

**IMPORTANT SAFETY INSTRUCTIONS**

**WARNING**

**Instruction pertaining to a risk of fire, electric shock or injury to persons.**

These product may represent a possible shock or fire hazard if improperly installed or attached in any way. Products should be installed in accordance with these instructions, current electrical codes and/or the current National Electric Code (NEC). To reduce the risk of fire, electric shock or injury to persons, use only insulated staples or plastic ties to secure cords, route and secure cords so that they will not be pinched or damaged when the cabinet is pushed to the wall, position the portable cabinet light with respect to the cabinet so the lamp replacement marking are able to read during relamping. Not intended for installation in ceilings or soffits. Intended inside "built-in furnishings" such as kitchen cabinet or trophy case. The National Electrical Code (NEC) does not permit cords to be concealed where damage to insulation may go unnoticed. To prevent fire danger, do not run cord behind walls, ceilings, soffits or cabinet where it may be inaccessible for examination, cords should be examined periodically and immediately replaced when any damage is noted.

**Compatible power feed accessories (sold separately):**

**EUDCRD:** - 1.8meters (72") power cord to connect a 120V LED linear to a 120V outlet.

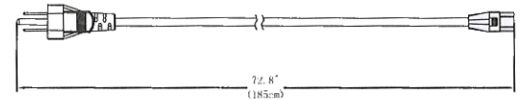

**EUDJBX:** - Junction box for hardwiring. Linears connect directly on to junction box.

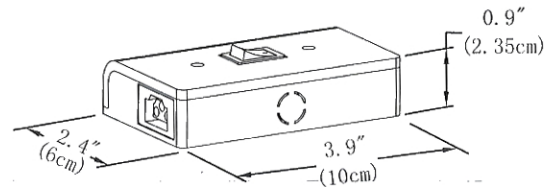

**Compatible extension cords (sold separately):**

**EUDC31:** - 6" (15 cm) extension cord to connect between two 120V LED linears.

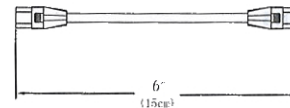

**EUDCS31:** - End-to-end connector.

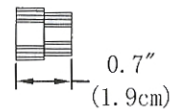

**Warranty:**

ELCO offers a warranty of 3 years for the LED linear light from the date of purchase that covers repair or replacement of defective parts of the housing, optics, and electronics. To contact ELCO customer service call to 1 800 522 2626 or send an email to [customerservice@elcolighting.com](mailto:customerservice@elcolighting.com).

# INSTRUCTIONS FOR LED 120V FLAT T5 TUBES

## EUD3230W/EUD3330W/EUD3430W EUD3530W/EUD3630W/EUD3730W



Sold separately: 1.8 m (72") power cord



Dimmable with most regular low voltage electronic dimmers



	Lumen per fixture	Total consumption
EUD3230W:	300lm	5W
EUD3330W:	480lm	8W
EUD3430W:	600lm	10W
EUD3530W:	720lm	12W
EUD3630W:	900lm	15W
EUD3730W:	1200lm	20W

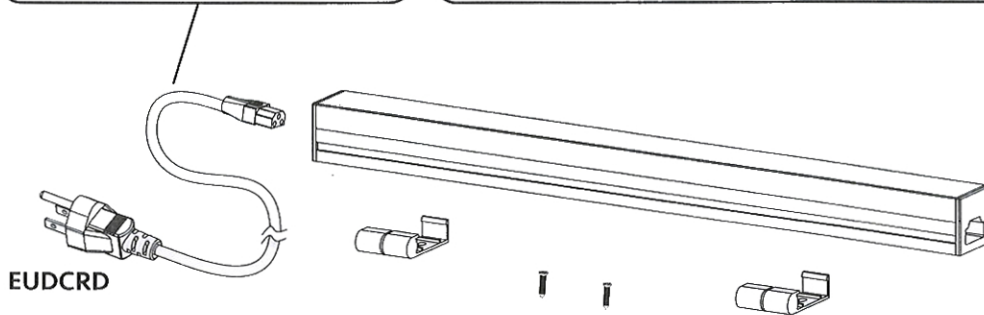

EUDCRD



EUDCS31



### Lighting

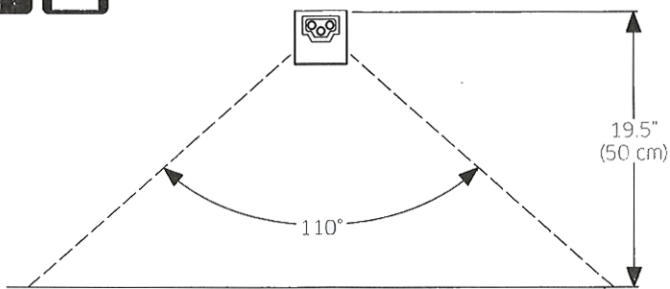

Approved for installation inside, under or over cabinets, with light shining in any directions



### Hardwire connection

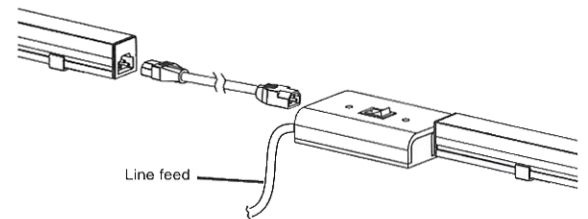

Line feed

Linears can be directly connected on to junction box, or be used with an extension cord.

### Installation instructions

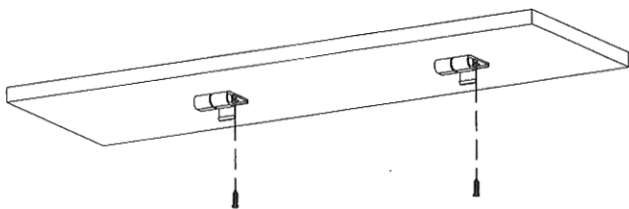

Install the brackets on a straight line, with 10" (25 cm) between each bracket

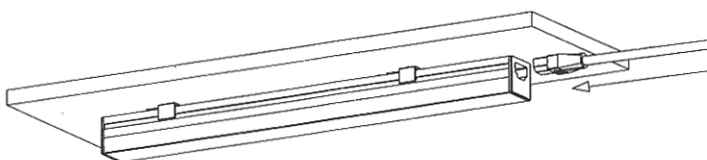

Push fixtures in brackets until a "click" is heard, then connect the power cord to fixture

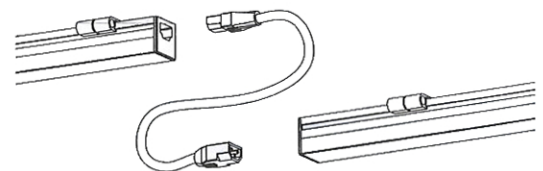
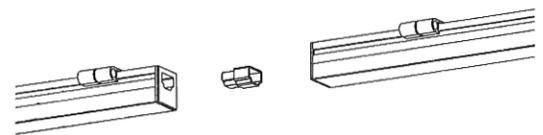

Plug others fixtures directly with the included end-to-end connector or with the extension cords.