

# 4" ARCHITECTURAL KOTO™ DOWNLIGHTING SYSTEM

10.5W-18.9W, 2700K-4000K, or Sunset, Up to 1950 lm, 120V or 120/277V

## THE ARCHITECTURAL KOTO™ SYSTEM

The high quality residential grade downlight with a 2" aperture with lumen output up to 1950 lumens.



### FEATURES

- Driver on housing extends lifespan and allows for more dimming options and applications
- Lumen output based on housing and module
- Driver on Housing: 120V, Triac/ELV dimming to 5% or 120-277V, 0-10V/Triac/ELV dimming to 1%
- 18°, 25°, 38°, 60°, and 90° beam angle options
- Excellent color rendering 95+ CRI
- Title 24 JA8-2022-E Compliant. ENERGY STAR Compliant
- Covered by U.S. PATENTS and Patents Pending

### SET UP

1. Select a New Construction or Remodel Housing.
2. Select a Koto™ Architectural LED Light Engine.
3. Select a Trim.



### SPECIFICATIONS

Wattage	10.5W - 18.9W
Lumens	750 lm - 1950 lm
Voltage	120V or 120/277V
Color Temp.	2700K, 3000K, 3500K, 4000K, or Sunset
CRI	95+
Damp Location	UL Listed Adjustable Trims
Wet Location	UL Listed Fixed Trims & Adjustable Trims with Glass Lens
Dimming	Triac/ELV (5%) or 0-10V/Triac/ELV (1%)
Beam Angle	18°, 25°, 38°, 60° & 90°

### Finishes

- White
- Black
- Bronze
- Black/ White
- Chrome/ White
- Haze/ White

## PRODUCT NUMBER BUILDER

**STEP 1.** Specify Housing part number (Select one)

Example: E4LK79ICAD

### 4" IC AIRTIGHT RECESSED HOUSINGS

ITEM	WATTAGE	VOLTAGE/DIMMING	EMERGENCY BATTERY BACKUP
<b>E4LK</b>			
<b>120V Maximum Adjustability New Construction Housings</b>			
<b>98<sup>1</sup></b>	14.7W (Shallow - 3 ½" Height)	<b>ICA</b> 120V - Triac/ELV IC Airtight	<b>EM5<sup>3</sup></b> 25W MAX
<b>47<sup>1,2</sup></b>	15.7W (5 ½" Height)		<b>-EM7<sup>4</sup></b> 15W MAX
<b>78<sup>1,2</sup></b>	18.9W (5 ½" Height)		
<sup>1</sup> Collar adjustable up to 1 ½" ceiling thickness <sup>2</sup> Not to be used with ELK19 Series			<sup>3</sup> Requires access above ceiling <sup>4</sup> For E4LK98ICA (14.7W) only with 5 ½" tall box, accessible from below
<b>120/277V Maximum Adjustability New Construction Housings</b>			
<b>99<sup>1</sup></b>	14.7W (Shallow - 3 ½" Height)	<b>ICAD</b> 120/277V - 0-10V/Triac/ELV IC Airtight	<b>EM5<sup>3</sup></b> 25W MAX - 120/277V
<b>48<sup>1,2</sup></b>	15.7W (5 ½" Height)		<b>-EM7<sup>4</sup></b> 15W MAX - 120V
<b>79<sup>1,2</sup></b>	18.9W (5 ½" Height)		
<sup>1</sup> Collar adjustable up to 1 ½" ceiling thickness <sup>2</sup> Not to be used with ELK19 Series			<sup>3</sup> Requires access above ceiling <sup>4</sup> For E4LK99ICAD (14.7W) only with 5 ½" tall box, accessible from below
<b>120V Standard New Construction/Remodel Housings</b>			
<b>87<sup>1</sup></b>	12.6W (New Construction - 5 ½" Height)	<b>ICA</b> 120V - Triac/ELV IC Airtight	<b>EM5<sup>3</sup></b> 25W MAX
<b>87R<sup>1</sup></b>	10.5W (Remodel - 5 ½" Height)		
<sup>1</sup> Collar adjustable up to 1 ½" ceiling thickness			
<b>120/277V Standard New Construction/Remodel Housings</b>			
<b>88<sup>1</sup></b>	12.6W (New Construction - 5 ½" Height)	<b>ICAD</b> 120/277V - 0-10V/Triac/ELV IC Airtight	<b>EM5<sup>3</sup></b> 25W MAX - 120/277V
<b>88R<sup>1</sup></b>	11.8W (Remodel - 5 ½" Height)		
<sup>1</sup> Collar adjustable up to 1 ½" ceiling thickness			

# PRODUCT NUMBER BUILDER

**STEP 2.** Specify Architectural Koto™ LED Light Engine part number (Select one) Example: ELK2127D-W

ITEM	LUMENS	COLOR TEMPERATURE	BEAM ANGLE	
ELK				
ELK	<b>Architectural Koto LED Light Engine</b>			
	19'	750-1000	27D 2700K	(Blank) 38° <sup>4</sup>
	21'	950-1650	30D 3000K	-S 18°
	24'	1010-1950	35D 3500K	-N 25°
			40D 4000K	-W 60°
			SD <sup>2,3</sup> Sunset	-E 90° <sup>5</sup>
	<sup>1</sup> Lumen output varies based on the Architectural Koto Housing used (SEE CHART)	<sup>2</sup> Available with ELK19 module only <sup>3</sup> Sunset, Dim to Warm technology, automatically transitions from 3000K to 1800K when dimmed	<sup>4</sup> 38° installed on module with 25° & 60° included in the box <sup>5</sup> 90° available with frosted reflector only	
ELK	<b>Architectural Koto FOCUS LED Light Engine</b>			
	21'	800-1200	27D 2700K	-FC <sup>6</sup> 18°-50°
			30D 3000K	
			35D 3500K	
			40D 4000K	
	<sup>1</sup> Lumen output varies based on the Architectural Koto Housing used (SEE CHART)		<sup>6</sup> Adjustable Focus offers 18°-50° with a twist of the snoot.	

### Field Changeable Secondary Module Optics (Not Compatible with Koto Focus Module)

L45	L57	L46	L47	L49	L51	L52	L53	L54	L55	L50W	L50B
Black Hex Louver	White Hex Louver	Linear Lens	Spread Lens	Frosted Diffuser	CCT Reducer	Blue Color Shifter	Pink Color Shifter	Single Asymmetric	Double Asymmetric	White Snoot	Black Snoot

Nominal Delivered Lumens (Housing + Module)				
Compatible Architectural Housings Lumen Output (Per Module)	Standard Housings (10.5W) E4LK8 Series	Shallow Housings (14.7W) E4LK9 Series	High Lumen Housings (15.7W) E4LK4 Series	High Lumen Housings (18.9W) E4LK7 Series
<b>Architectural Koto™ LED Module</b>				
ELK19 Series	~750 lm	~1000 lm	Not Compatible	Not Compatible
ELK21 Series	~950 lm	~1200 lm	~1400 lm	~1650 lm
ELK24 Series	~1010 lm	~1400 m	~1750 lm	~1950 lm
<b>Architectural Koto™ FOCUS LED Module</b>				
ELK21XXD-FC Series	~800 lm	~1050 lm	~1200 lm	Not Compatible

Koto Modules - Lumen Value Multiplier			
CCT	Multiplier	Beam Angle	Multiplier
2700K	0.96	18°	0.84
3000K	1	25°	0.89
3500K	1.05	36°	1
4000K	1.085	60°	1.065
		90°	0.95

## PRODUCT NUMBER BUILDER

### STEP 3. Specify Trim part number (Select one)

#### 4" KOTO™ ROUND TRIMS



Style: **Adjustable Reflector with Clear Glass**

Item: **ELK4111W** (All White)  
**ELK4111BB** (All Black)  
**ELK4111BZ** (All Bronze)  
**ELK4111B** (Black/White Ring)  
**ELK4111C** (Chrome/White Ring)  
**ELK4111H** (Haze/White Ring)



Style: **Adjustable Reflector with Frosted Glass**

Item: **ELK4112W** (All White)  
**ELK4112BB** (All Black)  
**ELK4112BZ** (All Bronze)  
**ELK4112B** (Black/White Ring)  
**ELK4112C** (Chrome/White Ring)  
**ELK4112H** (Haze/White Ring)



Style: **Adjustable Reflector**

Item: **ELK4129W** (All White)  
**ELK4129BB** (All Black)  
**ELK4129BZ** (All Bronze)  
**ELK4129B** (Black/White Ring)  
**ELK4129C** (Chrome/White Ring)  
**ELK4129H** (Haze/White Ring)



Style: **Fixed Deep Reflector**

Item: **ELK4118W** (All White)  
**ELK4118BB** (All Black)  
**ELK4118BZ** (All Bronze)  
**ELK4118B** (Black/White Ring)  
**ELK4118C** (Chrome/White Ring)  
**ELK4118H** (Haze/White Ring)



Style: **Adjustable Pinhole**

Item: **ELK4127W** (All White)  
**ELK4127BB** (All Black)  
**ELK4127BZ** (All Bronze)  
**ELK4127B** (Black/White Ring)  
**ELK4127H** (Haze/White Ring)



Style: **Adjustable Pinhole with Frosted Lens**

Item: **ELK4125W** (All White)  
**ELK4125BB** (All Black)  
**ELK4125BZ** (All Bronze)  
**ELK4125H** (Haze/White Ring)



Style: **Shallow Reflector**

Item: **ELK4116W** (All White)  
**ELK4116H** (Haze/White Ring)



Style: **Rotatable Slot Aperture**

Item: **ELK4120W** (Black Slot/White Ring)  
Must be used with Maximum Adjustability Housings



Style: **Adjustable Reflector Wall Wash**

Item: **ELK4122W** (All White)  
Must be used with Maximum Adjustability Housings



Style: **Adjustable Slot Aperture**

Item: **ELK4130W** (Black Slot/White Ring)  
Must be used with Maximum Adjustability Housings



Style: **Micro Flange Regressed Eyeball**

Item: **ELK4153W** (All White)  
**ELK4153BB** (All Black)



Style: **Micro Flange Reflector**

Item: **ELK4163W** (All White)  
**ELK4163BB** (All Black)



Style: **Curved Reflector**

Item: **ELK4172W** (All White)  
**ELK4172B** (All Black)



Style: **Directional Gimbal**

Item: **ELK4179W** (All White)  
**ELK4179BB** (All Black)  
**ELK4179B** (Black/White Ring)  
**ELK4179H** (Haze/White Ring)



Style: **Adjustable Spot**

Item: **ELK4188W** (All White)  
**ELK4188B** (All Black)  
**ELK4188BZ** (All Bronze)



Style: **Adjustable Baffle**

Item: **ELK4193W** (All White)  
**ELK4193BB** (All Black)  
**ELK4193B** (Black/White Ring)



Style: **Adjustable Reflector**

Item: **ELK4710W** (All White)



Style: **Adjustable Baffle**

Item: **ELK4713W** (All White)

## PRODUCT NUMBER BUILDER

### STEP 3. Specify Trim part number (Select one)

#### 4" KOTO™ ROUND TRIMS



Style: **Adjustable Deep Reflector**  
Item: **ELK4717W** (All White)



Style: **Adjustable Deep Baffle**  
Item: **ELK4719W** (All White)



Style: **Adjustable Reflector**  
Item: **ELK4721WW** (All White)  
**ELK4721BB** (All Black)  
**ELK4721BZBZ** (All Bronze)  
**ELK4721BW** (Black/White Ring)



Style: **Adjustable Baffle**  
Item: **ELK4723WW** (All White)  
**ELK4723BB** (All Black)  
**ELK4723BZBZ** (All Bronze)  
**ELK4723BW** (Black/White Ring)



Style: **Flush Mount Spackle Frame**  
Item: **EL4FMR**  
Compatible with ELK4116, ELK4118, ELK4127,  
ELK4129, ELK4710, ELK4713, & ELK4715 trims

#### 4" KOTO™ SQUARE TRIMS



Style: **Fixed Deep Reflector**  
Item: **ELK4218W** (All White)  
**ELK4218BB** (All Black)  
**ELK4218BZ** (All Bronze)  
**ELK4218B** (Black/White Ring)  
**ELK4218C** (Chrome/White Ring)  
**ELK4218H** (Haze/White Ring)



Style: **Adjustable Gimbal**  
Item: **ELK4229W** (All White)  
**ELK4229BB** (All Black)  
**ELK4229BZ** (All Bronze)  
**ELK4229B** (Black/White Ring)  
**ELK4229C** (Chrome/White Ring)  
**ELK4229H** (Haze/White Ring)



Style: **Shallow Reflector**  
Item: **ELK4216W** (All White)  
**ELK4216H** (Haze/White Ring)



Style: **Slot Rotatable Aperture**  
Item: **ELK4220W** (Black Slot/White Ring)  
Must be used with Maximum Adjustability Housings



Style: **Adjustable Wall Wash**  
Item: **ELK4222W** (All White)  
Must be used with Maximum Adjustability Housings



Style: **Adjustable Pinhole**  
Item: **ELK4227W** (All White)  
**ELK4227BB** (All Black)  
**ELK4227BZ** (All Bronze)  
**ELK4227B** (Black/White Ring)  
**ELK4227H** (Haze/White Ring)



Style: **Adjustable Pinhole with Frosted Lens**  
Item: **ELK4212W** (All White)  
**ELK4212BB** (All Black)  
**ELK4212BZ** (All Bronze)  
**ELK4212B** (Black/White Ring)  
**ELK4212H** (Haze/White Ring)



Style: **Adjustable Reflector**  
Item: **ELK4282W** (All White)  
**ELK4282BZ** (All Bronze)



Style: **Adjustable Baffle**  
Item: **ELK4284W** (All White)  
**ELK4284B** (All Black)  
**ELK4284BZ** (All Bronze)

## PRODUCT NUMBER BUILDER

### STEP 3. Specify Trim part number (Select one)

#### 4" KOTO™ SQUARE TRIMS



Style: **Adjustable Phenolic Baffle**  
Item: **ELK4293W** (All White)  
**ELK4293BB** (All Black)  
**ELK4293B** (Black/White Ring)



Style: **Fixed Reflector**  
Item: **ELK4714W** (All White)  
Must be used with New Construction Housings

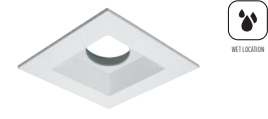

Style: **Fixed Baffle**  
Item: **ELK4716W** (All White)  
Must be used with New Construction Housings



Style: **Square Reflector**  
Item: **ELK4741WW** (All White)  
**ELK4741BB** (All Black)  
**ELK4741BZBZ** (All Bronze)  
**ELK4741BW** (Black/White Ring)  
**ELK4741HW** (Haze/White Ring)  
Must be used with New Construction Housings



Style: **Square Baffle**  
Item: **ELK4743WW** (All White)  
**ELK4743BB** (All Black)  
**ELK4743BZBZ** (All Bronze)  
**ELK4743BW** (Black/White Ring)  
Must be used with New Construction Housings



Style: **Adjustable Reflector**  
Item: **ELK4759WW** (All White)  
**ELK4759BB** (All Black)  
**ELK4759B** (Black/White Ring)  
**ELK4759H** (Haze/White Ring)  
Must be used with New Construction Housings



Style: **Flush Mount Spackle Frame**  
Item: **EL4FMS**  
Compatible with ELK4216, ELK4218, ELK4227,  
& ELK4229 trims

#### 4" KOTO™ ROUND TRIMLESS



Style: **Fixed Trimless Reflector**  
Item: **ELK408W** (All White)  
**ELK408B** (All Black)  
**ELK408BZ** (All Bronze)  
**ELK408H** (All Haze)  
Requires EL4SFR (Sold separately)



Style: **Adjustable Trimless Reflector**  
Item: **ELK415W** (All White)  
**ELK415B** (All Black)  
**ELK415BZ** (All Bronze)  
**ELK415H** (All Haze)  
Requires EL4SFR (Sold separately)

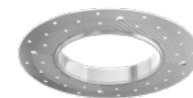

Style: **Trimless Spackle Frame**  
Item: **EL4SFR**  
For use with ELK408 & ELK415

#### 4" KOTO™ SQUARE TRIMLESS



Style: **Fixed Trimless Reflector**  
Item: **ELK445W** (All White)  
**ELK445B** (All Black)  
**ELK445H** (All Haze)  
Requires EL4SFS (Sold separately)



Style: **Adjustable Trimless Reflector**  
Item: **ELK459W** (All White)  
**ELK459B** (All Black)  
**ELK459H** (All Haze)  
Requires EL4SFS (Sold separately)



Style: **Trimless Spackle Frame**  
Item: **EL4SFS**  
For use with ELK445 & ELK459

## PRODUCT DIMENSIONS

### ARCHITECTURAL KOTO™ IC AIRTIGHT RECESSED HOUSINGS

**E4LK98/E4LK99**  
MAXIMUM ADJUSTABILITY SHALLOW NEW CONSTRUCTION HOUSING

3 1/2"  
4 1/8"  
7 1/2"  
12"

-EM7 housing is 5 1/2" tall

**E4LK47/E4LK48/E4LK78/E4LK79**  
MAXIMUM ADJUSTABILITY NEW CONSTRUCTION HOUSING

5 1/2"  
4 1/8"  
7 1/2"  
12"

For use with ELK21 & ELK24 Series only

**E4LK87/E4LK88**  
STANDARD NEW CONSTRUCTION HOUSING

5 1/2"  
4 1/4"  
5 7/8"  
8 5/8"

**E4LK87R/E4LK88R**  
STANDARD REMODEL HOUSING

5 1/2"  
4 1/4"  
4 3/4"  
9 1/4"

## PRODUCT DIMENSIONS

### ARCHITECTURAL KOTO™ LED LIGHT ENGINES

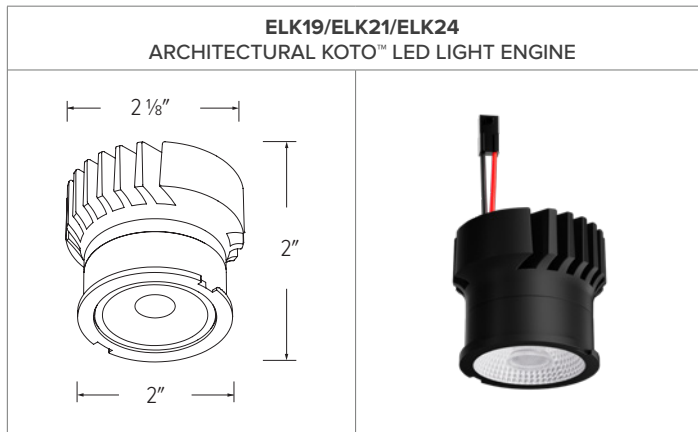



# PRODUCT DIMENSIONS

## KOTO™ ROUND TRIMS

**ELK4111 - 4" ROUND ADJUSTABLE REFLECTOR WITH CLEAR GLASS**

1 1/2"  
4"  
5"

358° Rotation - 25° - 35° Tilt

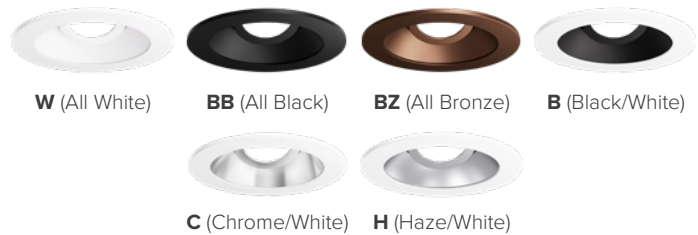

**ELK4112 - 4" ROUND ADJUSTABLE REFLECTOR WITH FROSTED LENS**

1 1/2"  
4"  
5"

358° Rotation - 25° - 35° Tilt

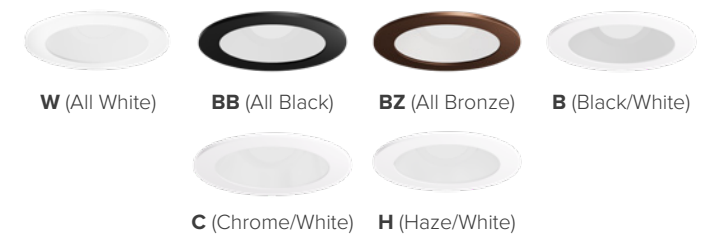

**ELK4129 - 4" ROUND ADJUSTABLE REFLECTOR**

1 1/2"  
4"  
5"

358° Rotation - 25° - 35° Tilt



**ELK4118 - 4" ROUND DEEP REFLECTOR**

2"  
3 5/8"  
5"



**ELK4116 - 4" ROUND SHALLOW REFLECTOR**

1 1/8"  
3 5/8"  
5"



**ELK4120 - 4" ROUND ROTATABLE SLOT APERTURE**

2"  
4"  
5"

358° Rotation - 45° Tilt  
Must be used with Maximum Adjustability Housings



# PRODUCT DIMENSIONS

## KOTO™ ROUND TRIMS

**ELK4122 - 4" ROUND ADJUSTABLE REFLECTOR WALL WASH**

3 1/4"  
3 3/4"  
5"

45° Tilt  
Must be used with Maximum Adjustability Housings



**W** (All White)

**ELK4130 - 4" ROUND ADJUSTABLE SLOT APERTURE**

2"  
2 3/8"  
5"

45° Tilt  
Must be used with Maximum Adjustability Housings



**W** (Black Slot/White)

**ELK4127 - 4" ROUND ADJUSTABLE PINHOLE**

1 3/8"  
2"  
5"

25° - 35° Tilt



**W** (All White)    **BB** (All Black)    **BZ** (All Bronze)



**B** (Black/White)    **H** (Haze/White)

**ELK4125 - 4" ROUND ADJUSTABLE PINHOLE WITH FROSTED LENS**

1 3/8"  
2"  
5"

25° - 35° Tilt



**W** (All White)    **BB** (All Black)    **BZ** (All Bronze)    **H** (Haze/White)

**ELK4153 - 4" ROUND REGRESSED EYEBALL**

1 1/2"  
3 1/2"  
5"

360° Rotation - 25° - 35° Tilt



**W** (All White)    **BB** (All Black)    **B** (Black/White)

**ELK4163 - 4" ROUND MICRO FLANGE REFLECTOR**

1 7/8"  
3 7/8"  
5"



**W** (All White)    **BB** (All Black)

# PRODUCT DIMENSIONS

## KOTO™ ROUND TRIMS

**ELK4172 - 4" ROUND CURVED REFLECTOR**



**ELK4179 - 4" ROUND DIRECTIONAL GIMBAL**

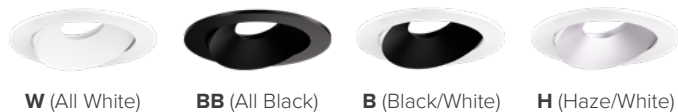

**ELK4188 - 4" ROUND ADJUSTABLE SPOT**



**ELK4193 - 4" ROUND ADJUSTABLE BAFFLE**



**ELK4710 - 4" ROUND ADJUSTABLE REFLECTOR**



**ELK4713 - 4" ROUND ADJUSTABLE BAFFLE**



# PRODUCT DIMENSIONS

## KOTO™ ROUND TRIMS

**ELK4717 - 4" ROUND ADJUSTABLE DEEP REFLECTOR**

1 3/4"

3 7/8"

5"

35° Tilt

DAMP LOCATION



**W** (All White)

**ELK4719 - 4" ROUND ADJUSTABLE DEEP BAFFLE**

1 3/4"

3 7/8"

5"

35° Tilt

DAMP LOCATION



**W** (All White)

**ELK4721 - 4" ROUND ADJUSTABLE REFLECTOR**

1 1/8"

3 1/8"

5"

35° Tilt

DAMP LOCATION



**WW** (All White)



**BB** (All Black)



**BZBZ** (All Bronze)



**BW** (Black/White)

**ELK4723 - 4" ROUND ADJUSTABLE BAFFLE**

1 1/8"

3 1/8"

5"

35° Tilt

DAMP LOCATION



**WW** (All White)



**BB** (All Black)

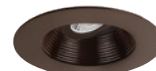

**BZBZ** (All Bronze)



**BW** (Black/White)

**EL4FMR - 4" ROUND FLUSH MOUNT SPACKLE FRAME**

4 1/2"

5"

7 1/8"

Compatible with ELK4116, ELK4118,  
ELK4127, ELK4129, ELK4710,  
ELK4713, & ELK4715 trims

# PRODUCT DIMENSIONS

## KOTO™ SQUARE TRIMS

**ELK4216 - 4" SQUARE SHALLOW REFLECTOR**

1 1/8"

3 5/8"

5"

NET LOCATION



**W** (All White)



**H** (Haze/White)

**ELK4220 - 4" SQUARE ROTATABLE SLOT APERTURE**

2"

4"

5"

DAMP LOCATION

358° Rotation - 45° Tilt  
Must be used with Maximum Adjustability Housings



**W** (Black Slot/White)

**ELK4222 - 4" SQUARE ADJUSTABLE WALL WASH**

3 1/4"

3 3/4"

5"

DAMP LOCATION

45° Tilt  
Must be used with Maximum Adjustability Housings



**W** (All White)

**ELK4218 - 4" SQUARE DEEP REFLECTOR**

2"

3 3/4"

5"

NET LOCATION



**W** (All White)



**BB** (All Black)



**BZ** (All Bronze)



**B** (Black/White)



**C** (Chrome/White)



**H** (Haze/White)

**ELK4227 - 4" SQUARE ADJUSTABLE PINHOLE**

1 1/2"

2 1/2"

5"

DAMP LOCATION

25° - 35° Tilt



**W** (All White)



**BB** (All Black)



**BZ** (All Bronze)



**B** (Black/White)



**H** (Haze/White)

**ELK4212 - 4" SQUARE ADJUSTABLE PINHOLE WITH FROSTED LENS**

1 1/2"

2 1/2"

5"

NET LOCATION

25° - 35° Tilt



**W** (All White)



**BB** (All Black)



**BZ** (All Bronze)



**B** (Black/White)



**H** (Haze/White)

# PRODUCT DIMENSIONS

## KOTO™ SQUARE TRIMS

**ELK4229 - 4" SQUARE ADJUSTABLE REFLECTOR**

358° Rotation - 25° - 35° Tilt

**ELK4282 - 4" SQUARE ADJUSTABLE REFLECTOR**

358° Rotation - 35° Tilt

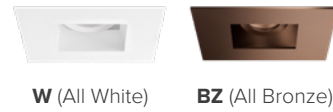

**ELK4284 - 4" SQUARE ADJUSTABLE BAFFLE**

358° Rotation - 35° Tilt

**ELK4293 - 4" SQUARE ADJUSTABLE PHENOLIC BAFFLE**

35° Tilt



**ELK4714 - 4" SQUARE REFLECTOR**

Must be used with Maximum Adjustability Housings

**ELK4716 - 4" SQUARE BAFFLE**

Must be used with Maximum Adjustability Housings



# PRODUCT DIMENSIONS

## KOTO™ SQUARE TRIMS

**ELK4741 - 4" SQUARE REFLECTOR**

1 1/8"

2 3/8"

4 3/4"

Must be used with Maximum Adjustability Housings

**ELK4743 - 4" SQUARE BAFFLE**

1 1/8"

2 3/8"

4 3/4"

Must be used with Maximum Adjustability Housings



**ELK4759 - 4" SQUARE ADJUSTABLE REFLECTOR**

1 1/8"

2 3/8"

4 3/4"

25° - 35° Tilt  
Must be used with Maximum Adjustability Housings

**EL4FMS - 4" SQUARE FLUSH MOUNT SPACKLE FRAME**

4 1/16"

4 3/8"

7 1/8"

Compatible with ELK4216, ELK4218, ELK4229, & ELK4227 trims

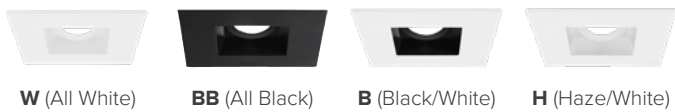

# PRODUCT DIMENSIONS

## KOTO™ ROUND TRIMLESS

**ELK408 - 4" ROUND TRIMLESS REFLECTOR**

Requires EL4SFR (Sold Separately)

**ELK415 - 4" ROUND ADJUSTABLE TRIMLESS REFLECTOR**

35° Tilt  
Requires EL4SFR (Sold Separately)



**EL4SFR - 4" ROUND TRIMLESS SPACKLE FRAME**

4"  
7 1/8"  
For use with ELK408 & ELK415



# PRODUCT DIMENSIONS

## KOTO™ SQUARE TRIMLESS

**ELK445 - 4" SQUARE TRIMLESS REFLECTOR**

Requires EL4SFS (Sold Separately)

**ELK459 - 4" SQUARE ADJUSTABLE TRIMLESS REFLECTOR**

35° Tilt  
Requires EL4SFS (Sold Separately)







**EL4SFS - 4" SQUARE TRIMLESS SPACKLE FRAME**

For use with ELK445 & ELK459

## ACCESSORIES

### LENS & OPTICS (field changeable)

FIELD CHANGEABLE LENS		HEX LOUVER	LINEAR LENS	SPREAD LENS
				
<b>EP731C</b> (18°) / <b>EP732C</b> (25°) <b>EP733C</b> (38°) / <b>EP734C</b> (60°)	<b>EP739C</b> (90°)	<b>L45</b> (Black) / <b>L57</b> (White) For a better glare shield	<b>L46</b> For a wide rectangular illumination pattern	<b>L47</b> For a symmetrical broadening of light beams

FROSTED DIFFUSER	COLOR SHIFTERS	SINGLE ASYMMETRIC LENS	DOUBLE ASYMMETRIC LENS	SNOOTS
				
<b>L49</b> For a softer light	<b>L51</b> (Color temp. reducer) <b>L52</b> (Blue) / <b>L53</b> (Pink)	<b>L54</b> For elliptical illumination pattern	<b>L55</b> For elliptical illumination pattern	<b>L50W</b> (White) / <b>L50B</b> (Black) Reduces glare and light spill

### FIRE RATED PRODUCTS

1-HOUR FIRE ENCLOSURE FOR RECESSED FIXTURES	MICA ADHESIVE FIRE TAPE FOR FIRE ENCLOSURE	2-HOUR FIRE COVER FOR RECESSED FIXTURES
		
<b>FIREENCL</b> Standard - 9" H x 20 3/8" L x 14 3/8" W <b>FIREENCL-S</b> Shallow (-S) - 7 1/4" H x 16" L x 14 3/8" W  Provides fire barrier around recessed lights. ETL approved 1-hour fire rating. Meets UL 263, ASTM E119 Specifications. To be used with Mica Tape to seal the power feeding point. (FIRETAPE sold separately)	<b>FIRETAPE</b> 3/4" W x 16' L  Fire proof mica adhesive tape helps seal the power feeding point on Fire Enclosure. Offers outstanding high temperature and flame resistance, and provides excellent electrical insulation.	<b>FIRECVR</b> 9 3/4" H x 17" O.D. x 13" I.D.  Made of heat activated intumescent material. UL approved for most ceiling types: sheetrock drywall, gypsum & acoustical tiles. UL Rated enclosure stops flame spread and heat transmission for up to 2 hours.

### EMERGENCY BATTERY BACKUP

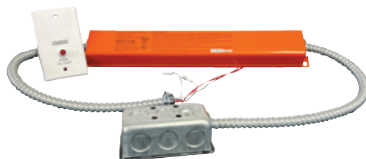
EMERGENCY BATTERY BACKUP

<b>KEM-ERT</b>  90 minutes of emergency operation. Input: 100-277VAC, 50/60Hz., 25W Max Output: 170VDC, 25W Charging time: 36 hours cUL listed - Suitable for damp location

---

## TECHNICAL DETAILS

---

**Optics:** PC lens diffuses light evenly throughout while reducing glare with LED COB technology.

**Construction (Light Engine):** Diecast aluminum body with heat fins allow for efficient cooling.

**Installation (Light Engine):** Twist-on design for toolless trim installation, for use with Koto™ trims only. Can be use in 2", 3", 4" & 6" Architectural Koto™ Housings only.

**Hanger Bars:** Pre-installed hanger bars with True Nail easy installation in regular lumber, engineered lumber, and laminated beams. Integral T-bar slots for easy installation in T-bars. Spans up 24" and can be repositioned 90°. Score lines allow for tool-free hanger bar size reduction. Integral leveling flange allows for single-person installation while easily aligning the housings with the joists.

**LED Technology:** Extremely accurate Color Rendering Index (CRI) of 95+. Lumen Maintainece of 50,000 hours L70 Life based on LM80 standardized test results. Superior Thermal Management by utilizing integrated heat sink. Instant On to Full Brightness. No LED pixilation.

**Electrical:** Drivers are rated for 120V or 120/277V input. High Efficiency driver with a power factor >0.95.

**Dimming:** Triac/ELV dimming (5%) or Triac/ELV/0-10V dimming (1%)

**Sunset:** Sunset color temperature is our dim-to-warm LED technology that allows the color temperature to become warmer as the product is dimmed. Our SUNSET items start at 3000K and go as low as 1800K when dimmed. For Sunset dim technology be sure to order an item with "Sunset (SDD)" in the Color Temperature (CCT) attribute.

**Emergency Battery Pack:** Optional 25W MAX. 90 minute battery backup for 4" accessible from below for single wall housings, access from above required for double wall housings.

**Listings:** UL & cUL Listed for Damp Location with Damp Location trims and Wet Location with Wet Location trims. RoHS Compliant. ENERGY STAR® Compliant. Title 24 JA8-2022-E Compliant.

**Warranty:** ELCO Products are built to last with a 5-year Limited warranty.

## DIMMER COMPATIBILITY CHART

### FOR REFERENCE ONLY

Testing conducted by ELCO Lighting is not a substitute for and does not imply certification by an independent laboratory or any other standards certification. Refer to manufacturer specifications for more detailed information on product certifications and standards. Consult the dimmer manufacturer prior to installation to ensure compatibility.

MANUFACTURER	PRODUCT	PART NUMBER	DIMMED LIGHT OUTPUT RANGE
<b>Triac/ELV Type Dimmers - 120V Only for E2LK35, E2LK42, E2LK95, E3LK77, E3LK54, E3LK85, E3LK66, ELK73FICA, E4LK99, E4LK48, E4LK79, E4LK88, E4JB85, ELK94FICA, E6LK44, E6LK57, E6LK38 Series</b>			
Lutron	120V AC, 150W LED/CFL or 600W Incandescent/Halogen, Single Pole, 3-Way	RRD-6CL	1% - 100%
	120V AC 60Hz, 150W LED/CFL/Incandescent/Halogen, Single Pole, 3-Way,	DVCL-153P	1% - 100%
	120V 60Hz, 150W LED/CFL or 600W Incandescent/Halogen, Single Pole, 3-Way	TGCL-153P	1% - 100%
	120V AC 60Hz, 300W Electronic Low Voltage, 3-Way, Commercial/Residential Application	DVELV-303P	1% - 100%
	120V, 600W Incandescent/Halogen, Single Pole, Residential Indoor Application	TG-600P	1% - 100%
	120V, 1000W Incandescent or 600W Magnetic Low Voltage, Single Pole, 3-Way	CT103P	1% - 100%
	120V AC 60Hz, 600W Electronic Low Voltage, Single Pole/Multi-Location	MAELV600	1% - 100%
	120V AC 60Hz, 500W Electronic Low Voltage, Single Pole/Multi-Location	FAELV500	1% - 100%
	120V AC 60Hz, 600W Incandescent/Halogen, Single Pole, Slide-to-Off Dimmer	S-600P	1% - 100%
	120V AC 60Hz, 150W LED/CFL or 600W Incandescent/Halogen, Single Pole, 3-Way	SCL-153P	1% - 100%
	Caséta® Wireless Dimmer	PD-6WCL	1% - 100%
	120V AC 60Hz, Low Voltage Load Type, 150W Single Pole	DVLV-600P	5% - 100%
	120V AC, 60Hz, 600W Incandescent/Halogen, Single Pole, 3-Way, Residential and Commercial Application	DV-603P	1% - 100%
	120V AC, 50/60Hz, 150W LED/CFL, 600W Incandescent/Halogen, Single Pole, 3-Way, Indoor Application	MA-PRO	1% - 100%
	120V AC 60Hz, 150W LED/CFL or 600W Incandescent/Halogen, Single Pole, 3-Way,	MACL-153M	1% - 100%
Leviton	120V AC 60Hz, 300W Electronic Low Voltage, 400 Volt Amp, Single Pole, 3-Way	IPE04	1% - 100%
	120V AC 60Hz, 300W CFL or 600W Incandescent, 400 Volt Amp, Single Pole, 3-Way	6673-10W	1% - 100%
	120V AC, 600W Incandescent with LED Locator, Single Pole, 3-Way	VP106	1% - 100%
	120V AC 60Hz, 500W Incandescent with LED Level Indicator, Single Pole, 3-Way	6161	1% - 100%
	120V AC, 150W LED/CFL or 600W Incandescent, Single Pole, 3-Way	6674	1% - 100%
Eaton	120V AC, 300W LED/CFL or 600W Incandescent/MLV/Halogen, Single Pole, 3-Way	TAL06P1-C1	1% - 100%
Cooper	120V AC 60Hz, 300W LED/CFL or 600W Incandescent/Halogen, Single Pole, 3-Way	SLC03P / DAL06P	1% - 100%
	120V AC 60Hz, 300W LED/CFL or 600W Incandescent, Single Pole, 3-Way	DLC03P	1% - 100%
	120V AC 60Hz, 600W Incandescent/Halogen, Single Pole, 3-Way,	RI061-VW-K2	1% - 100%
	120V AC 60Hz, 300W LED/CFL/ Incandescent/Halogen, Single Pole, 3-Way	AAL06A-C2	1% - 100%
Lightolier	120V, 260W Incandescent/Halogen, Single Pole, 3-Way	ZP260QEW	1% - 100%
<b>0-10V Type Dimmers - 120/277V</b>			
Lutron	120/277V AC, 0-10V LED/CFL Ballast, Single Pole, 3-Way	NFTV	1% - 100%
	120/277V AC, 0-10V, Single Pole, 3-Way, Commercial and Residential, Indoor Application	DVSTV	1% - 100%
	120/277V AC 50/60Hz, 0-10V LED/CFL Ballast, Single Pole, 3-Way, Indoor Application	DVTV	1% - 100%
Leviton	120/277V AC 60Hz, 0-10V LED/CFL Ballast, Single Pole, 3-Way	IP710-DL	1% - 100%

**\*NOTE: Refer to dimmer manufacturer's documentation for installation instructions and circuit details**

Disclaimer: Minimum and maximum loads for LEDs and CFLs are given in number of lamps and may vary depending on the lamp being used. Testing conducted by ELCO Lighting is not a substitute for and does not imply certification by an independent laboratory or any other standards certification. Refer to manufacturer specifications for more detailed information on product certifications and standards.

Integrating our lighting with your Smart Home System is a breeze. Simply check your Smart Home system for compatible smart switches and cross reference that with our Dimming Compatibility Chart. Once the switches are integrated with your Smart Home system your lights will be ready to go.



## DIMMER COMPATIBILITY CHART

### FOR REFERENCE ONLY

Testing conducted by ELCO Lighting is not a substitute for and does not imply certification by an independent laboratory or any other standards certification. Refer to manufacturer specifications for more detailed information on product certifications and standards. Consult the dimmer manufacturer prior to installation to ensure compatibility.

MANUFACTURER	PRODUCT	PART NUMBER	DIMMED LIGHT OUTPUT RANGE
<b>120V - Triac/ELV Dimmers for E2LK34, E2LK41, E2LK94, E2LK57, E3LK76, E3LK53, E3LK84, E3LK65, E4LK98, E4LK47, E4LK78, E4LK87, E4JB85, E6LK43, E6LK56, E6LK37, ELK72FICA, ELK93FICA Series</b>			
Cooper	Decorator Dimmer, 120V 60Hz, 300W LED and CFL, 600W Incandescent, Single Pole, 3-Way, Polycarbonated Housing	DLC03P	10% - 100%
Leviton	120V AC 60Hz, 300W Electronic Low Voltage, Single Pole, 3-Way,	1A1505 / 1C1605	10% - 100%
	120V AC 60Hz, 600W for LED and CFL, 600W for Incandescent, Single Pole, 3-Way, Polycarbonated Housing	6631 / 6633	5% - 100%
Lutron	Skylark Model, 120V AC 60Hz, 600W Incandescent/Halogen Load Type, Single Pole, 3-Way, Commercial/Residential, Indoor Application	CT-603PG CT-600PR	10% - 100%
	Diva Model, 120V 60Hz, 600W Incandescent/Halogen Load Type, Single Pole, 3-Way, Residential Grade Application	DV-600PR DV603PG	10% - 100%
	Diva Model, 120V AC 60Hz, 600W Incandescent/Halogen Load Type, Single Pole, 3-Way, Commercial/Residential	DVW-603PGH DVCL-153P	10% - 100%
	Maestro Model, 120V AC 60Hz, 150W for LED and CFL, 600W for Incandescent/Halogen Load Rating, Single Pole, 3-Way, Multi-Location Operation, Commercial/Residential, Indoor Application	MACL-153M TGCL-153P	10% - 100%
	Skylark Model, 120V AC 60Hz, 300W Incandescent/Halogen Load Type, Single Pole, 3-Way, Commercial/Residential	S-600PR S-2-LH	5% - 100%

**\*NOTE: Refer to dimmer manufacturer's documentation for installation instructions and circuit details**

Disclaimer: Minimum and maximum loads for LEDs and CFLs are given in number of lamps and may vary depending on the lamp being used. Testing conducted by ELCO Lighting is not a substitute for and does not imply certification by an independent laboratory or any other standards certification. Refer to manufacturer specifications for more detailed information on product certifications and standards.

Integrating our lighting with your Smart Home System is a breeze. Simply check your Smart Home system for compatible smart switches and cross reference that with our Dimming Compatibility Chart. Once the switches are integrated with your Smart Home system your lights will be ready to go.



# KOTO™ ARCHITECTURAL LED MODULE

PHOTOMETRIC REPORT	CANDLE POWER SUMMARY		ILLUMINANCE AT A DISTANCE		
<b>Product #:</b> ELK2127D <b>Wattage / Lumens:</b> 12.22W / 1169.3 lm <b>Luminaire LPW:</b> 95.7 lm/W	Degree Vertical	0°	Distance to Target Plane	Center Beam Footcandles	Beam Diameter
	0	1829	4'	114	3.0'
	5	1737	6'	50.8	4.6'
	15	1353	8'	28.6	6.1'
	25	683	10'	18.3	7.6'
	35	328	<b>ZONAL LUMEN SUMMARY</b>		
	45	123			
	55	39	Zone	Lumens	%Luminaire
	65	17	0-30°	834.5	71.2
	75	8	0-40°	1,022.9	87.3
	85	2	0-60°	1,140.0	97.3
	90	1	0-90°	1,164.3	99.4

PHOTOMETRIC REPORT	CANDLE POWER SUMMARY		ILLUMINANCE AT A DISTANCE		
<b>Product #:</b> ELK2130D-W (E4LK79ICAD) <b>Wattage / Lumens:</b> 17.9W / 1584.3 lm <b>Luminaire LPW:</b> 88.5 lm/W	Degree Vertical	0°	Distance to Target Plane	Center Beam Footcandles	Beam Diameter
	0	1880	4'	118	3.9'
	5	1753	6'	52.2	5.9'
	15	1396	8'	29.4	7.9'
	25	892	10'	18.8	9.8'
	35	399	<b>ZONAL LUMEN SUMMARY</b>		
	45	170			
	55	50	Zone	Lumens	%Luminaire
	65	21	0-30°	1,042.6	65.8
	75	11	0-40°	1,346.3	85
	85	6	0-60°	1,545.5	97.6
	90	5	0-90°	1,584.0	100

PHOTOMETRIC REPORT	CANDLE POWER SUMMARY		ILLUMINANCE AT A DISTANCE		
<b>Product #:</b> ELK2135D <b>Wattage / Lumens:</b> 12.22W / 1271 lm <b>Luminaire LPW:</b> 104 lm/W	Degree Vertical	0°	Distance to Target Plane	Center Beam Footcandles	Beam Diameter
	0	1976	4'	124	3.0'
	5	1877	6'	54.9	4.6'
	15	1462	8'	30.9	6.1'
	25	738	10'	19.8	7.6'
	35	355	<b>ZONAL LUMEN SUMMARY</b>		
	45	133			
	55	43	Zone	Lumens	%Luminaire
	65	18	0-30°	901.7	71.2
	75	9	0-40°	1,105.3	87.3
	85	2	0-60°	1,231.8	97.3
	90	1	0-90°	1,258.1	99.4

PHOTOMETRIC REPORT	CANDLE POWER SUMMARY		ILLUMINANCE AT A DISTANCE		
<b>Product #:</b> ELK2135D (E4LK79ICAD) <b>Wattage / Lumens:</b> 15.95W / 1683.5 lm <b>Luminaire LPW:</b> 105.5 lm/W	Degree Vertical	0°	Distance to Target Plane	Center Beam Footcandles	Beam Diameter
	0	4560	4'	285	2.4'
	5	4053	6'	127	3.5'
	15	2279	8'	71.3	4.7'
	25	633	10'	45.6	5.9'
	35	118	<b>ZONAL LUMEN SUMMARY</b>		
	45	68			
	55	47	Zone	Lumens	%Luminaire
	65	26	0-30°	1,469.0	87.3
	75	12	0-40°	1,563.6	92.9
	85	5	0-60°	1,645.0	97.8
	90	0	0-90°	1,682.4	100

# KOTO™ ARCHITECTURAL LED MODULE

PHOTOMETRIC REPORT	CANDLE POWER SUMMARY		ILLUMINANCE AT A DISTANCE		
<b>Product #:</b> ELK2135D-S (E4LK79ICAD) <b>Wattage / Lumens:</b> 18.8W / 1466.8 lm <b>Luminaire LPW:</b> 78 lm/W	Degree Vertical	0°	Distance to Target Plane	Center Beam Footcandles	Beam Diameter
	0	7355	4'	294	1.8'
	5	4640	6'	131	2.6'
	15	976	8'	73.5	3.5'
	25	304	10'	47.1	4.4'
	35	119	<b>ZONAL LUMEN SUMMARY</b>		
	45	55			
	55	27	Zone	Lumens	%Luminaire
	65	10	0-30°	1,258.7	86
	75	0	0-40°	1,358.0	92.8
	85	0	0-60°	1,442.4	98.5
	90	0	0-90°	1,458.6	99.7

PHOTOMETRIC REPORT	CANDLE POWER SUMMARY		ILLUMINANCE AT A DISTANCE		
<b>Product #:</b> ELK2135D-N (E4LK79ICAD) <b>Wattage / Lumens:</b> 18.9W / 1585.1 lm <b>Luminaire LPW:</b> 83.8 lm/W	Degree Vertical	0°	Distance to Target Plane	Center Beam Footcandles	Beam Diameter
	0	6310	4'	252	2.0'
	5	4684	6'	112	3.0'
	15	1771	8'	63.1	4.0'
	25	531	10'	40.4	5.0'
	35	114	<b>ZONAL LUMEN SUMMARY</b>		
	45	29			
	55	18	Zone	Lumens	%Luminaire
	65	11	0-30°	1,415.7	89.2
	75	0	0-40°	1,524.4	96.1
	85	8	0-60°	1,573.5	99.5
	90	6	0-90°	1,586.8	100

PHOTOMETRIC REPORT	CANDLE POWER SUMMARY		ILLUMINANCE AT A DISTANCE		
<b>Product #:</b> ELK2135D -W (E4LK79ICAD) <b>Wattage / Lumens:</b> 17.9W / 1647.3 lm <b>Luminaire LPW:</b> 92 lm/W	Degree Vertical	0°	Distance to Target Plane	Center Beam Footcandles	Beam Diameter
	0	1955	4'	122	3.9'
	5	1824	6'	54.3	5.9'
	15	1452	8'	30.6	7.9'
	25	928	10'	19.6	9.8'
	35	415	<b>ZONAL LUMEN SUMMARY</b>		
	45	177			
	55	52	Zone	Lumens	%Luminaire
	65	21	0-30°	1,084.3	65.8
	75	11	0-40°	1,400.1	85
	85	6	0-60°	1,607.3	97.6
	90	5	0-90°	1,647.4	100

PHOTOMETRIC REPORT	CANDLE POWER SUMMARY		ILLUMINANCE AT A DISTANCE		
<b>Product #:</b> ELK2140D <b>Wattage / Lumens:</b> 12.22W / 1322 lm <b>Luminaire LPW:</b> 108.2 lm/W	Degree Vertical	0°	Distance to Target Plane	Center Beam Footcandles	Beam Diameter
	0	2051	4'	128	3.0'
	5	1948	6'	57.0	4.6'
	15	1518	8'	32.1	6.1'
	25	766	10'	20.5	7.6'
	35	368	<b>ZONAL LUMEN SUMMARY</b>		
	45	138			
	55	44	Zone	Lumens	%Luminaire
	65	19	0-30°	935.9	71.2
	75	9	0-40°	1,147.2	87.3
	85	2	0-60°	1,278.5	97.3
	90	1	0-90°	1,305.8	99.4

# KOTO™ ARCHITECTURAL LED MODULE

PHOTOMETRIC REPORT	CANDLE POWER SUMMARY		ILLUMINANCE AT A DISTANCE		
Product #: ELK2430D-S (E3LK84ICA) Wattage / Lumens: 18.7 W / 1754.1 lm Luminaire LPW: 93.8 lm/W	Degree Vertical	0°	Distance to Target Plane	Center Beam Footcandles	Beam Diameter
	0	9659	4'	604	1.4'
	5	6457	6'	268	2.1'
	15	1223	8'	151	2.8'
	25	353	10'	96.6	3.4'
	35	153	ZONAL LUMEN SUMMARY		
	45	80			
	55	49	Zone	Lumens	%Luminaire
	65	27	0-30°	1,442.4	82.2
	75	12	0-40°	1,559.7	88.9
	85	0	0-60°	1,680.9	95.8
	90	0	0-90°	1,729.5	98.5
Product #: ELK2430D-N (E3LK84ICA) Wattage / Lumens: 18.9 W / 1785.6 lm Luminaire LPW: 94.4 lm/W	Degree Vertical	0°	Distance to Target Plane	Center Beam Footcandles	Beam Diameter
	0	6675	4'	417	1.8'
	5	5912	6'	185	2.8'
	15	2693	8'	104	3.7'
	25	687	10'	66.7	4.6'
	35	146	ZONAL LUMEN SUMMARY		
	45	61			
	55	47	Zone	Lumens	%Luminaire
	65	32	0-30°	1,561.9	87.5
	75	16	0-40°	1,659.9	93
	85	5	0-60°	1,739.2	97.5
	90	0	0-90°	1,784.1	100
Product #: ELK2430D-N (E3LK84ICA) Wattage / Lumens: 18.9 W / 1785.6 lm Luminaire LPW: 94.4 lm/W	Degree Vertical	0°	Distance to Target Plane	Center Beam Footcandles	Beam Diameter
	0	4517	4'	181	3.2'
	5	4217	6'	80.3	4.7'
	15	2680	8'	45.2	6.3'
	25	883	10'	28.9	7.9'
	35	181	ZONAL LUMEN SUMMARY		
	45	90			
	55	56	Zone	Lumens	%Luminaire
	65	32	0-30°	1,575.0	84.4
	75	15	0-40°	1,707.2	91.5
	85	6	0-60°	1,820.7	97.6
	90	0	0-90°	1,865.9	100
Product #: ELK2435D-S (E4LK79ICAD) Wattage / Lumens: 18.7 W / 1795.2 lm Luminaire LPW: 96 lm/W	Degree Vertical	0°	Distance to Target Plane	Center Beam Footcandles	Beam Diameter
	0	9865	4'	395	1.6'
	5	6595	6'	175	2.3'
	15	1249	8'	98.7	3.1'
	25	361	10'	63.1	3.9'
	35	156	ZONAL LUMEN SUMMARY		
	45	82			
	55	50	Zone	Lumens	%Luminaire
	65	27	0-30°	1,473.2	82.2
	75	12	0-40°	1,593.0	88.9
	85	0	0-60°	1,716.8	95.8
	90	0	0-90°	1,766.4	98.5



# KOTO™ ARCHITECTURAL LED MODULE

PHOTOMETRIC REPORT	CANDLE POWER SUMMARY		ILLUMINANCE AT A DISTANCE		
Product #: ELK2435D-N (E4LK79ICAD) Wattage / Lumens: 18.9 W / 1858 lm Luminaire LPW: 98.3 lm/W	Degree Vertical	0°	Distance to Target Plane	Center Beam Footcandles	Beam Diameter
	0	6942	4'	278	2.3'
	5	6148	6'	123	3.4'
	15	2800	8'	69.4	4.6'
	25	715	10'	44.4	5.7'
	35	152	<b>ZONAL LUMEN SUMMARY</b>		
	45	64			
	55	48	0-30°	1,624.3	87.5
	65	33	0-40°	1,726.3	93
	75	17	0-60°	1,808.7	97.5
	85	5	0-90°	1,855.4	100
	90	0			