

1" LED DOWNLIGHTS

120V AC 6.1W, 2700K - 4000K, Sunset, 450 - 675 lm

THE OAK™ SYSTEM

Small aperture 12V AC Downlight delivers over 600 lumens. More than a traditional 50W MR16 Halogen Lamp. Requires 12V AC Transformer (daisy chain up to 6). Dimmable ELV, MLV or 0-10V depending on transformer used.



FEATURES

- Requires 12V AC transformer. Dimmable ELV, MLV or 0-10V depending on the transformer used.
- IC Rated without a housing
- Height allows for use in ceilings with under 3" depth. Ceiling thickness can be reduced from fixture depth.
- Daisy chain up to 6 fixtures with E1LDRV60
- Remodel requires no frame. Frame available for new construction applications.
- JA8-2016-E & UL listed.
- Life Span 50,000 Hours L70

SET UP

1. Select a Transformer.
2. Select a Light Engine.
3. Select Optional Frame



Up to 6 Oak™ fixtures can be daisy-chained to one E1LDRV60

SPECIFICATIONS

Wattage	6.1W
Lumens	450lm - 675lm
Voltage	120V or 120/277V
Color Temp.	2700K, 3000K, 3500K, 4000K, Sunset
CRI	93+
Wet Location	Fixed trims
Damp Location	Adjustable trims
Dimming	ELV/MLV/0-10V
Beam Angle	28° 38° 50°

Finishes	White
	Bronze
	Black
	Haze/White
	Black/White

PRODUCT NUMBER BUILDER

◆ = ELCO's Choice

1. Specify transformer part number (Select one)

OAK™ COMPATIBLE TRANSFORMERS

12V AC TRANSFORMERS Example: LET-60-277

ITEM		WATTAGE		SPECIFICATIONS	
E1LDRV60 ◆		60W		Enclosed Electronic Transformer. 12V AC Output/120V Input/ELV Dimmable	
LET		-60			
LET	Electronic	-60	60W	(Blank)	120V Input/Side Lead/ELV Dimmable
				-277	277V Input/ Non-Dimmable
				H	120V Input/Bottom Lead/ELV Dimmable
				DX	120V Input/0-10V Dimmable
				DX-277	277V Input/0-10V Dimmable
ETR-12					
ETR-12	Magnetic			(Blank)	50W/120V Input/MLV Dimmable
				-20	20W/120V Input/MLV Dimmable

◆ = ELCO's Choice

2. Specify light engine part number

OAK LIGHT ENGINES

FIXED DOWNLIGHT LIGHT ENGINES Example: E1L02F27W

ITEM	STYLE	BEAM ANGLE	COLOR TEMP	FINISH
E1L				
E1L	02 ◆ Round Downlight ¹	F ◆ 38°	27 2700K	W ◆ All White
	12 Square Downlight ¹	NF 28°	30 ◆ 3000K	B Black/White ⁴
	61 Trimless Downlight ^{1,2}	WF 50°	35 3500K	BZ All Bronze
			40 4000K	H Haze/White ⁴
			SD Sunset ³	BB All Black
	¹ Wet location rated ² Requires Trimless Spackle Frame, EL01SFR , (sold separately)		³ Sunset, dim to warm technology, automatically transitions from 3000K to 1800K when dimmed	⁴ Not available for Trimless option

◆ = ELCO's Choice

TRIMLESS SPACKLE FRAME For use with E1L61

ITEM	DIMENSIONS
EL01SFR	2 3/8" I.D. - 4" O.D.

ADJUSTABLE LIGHT ENGINES Example: E1L22F27W

ITEM	STYLE	BEAM ANGLE	COLOR TEMP	FINISH
E1L				
E1L	22 Square Pull Down ¹	F ◆ 38°	27 2700K	W ◆ All White
	32 ◆ Round Gimbal ¹	NF 28°	30 ◆ 3000K	B All Black
		WF 50°	35 3500K	BZ All Bronze
			40 4000K	
	¹ Damp location rated			

◆ = ELCO's Choice

PRODUCT DIMENSIONS

OAK™ COMPATIBLE TRANSFORMERS

E1LDRV60 ENCLOSED ELECTRONIC TRANSFORMER

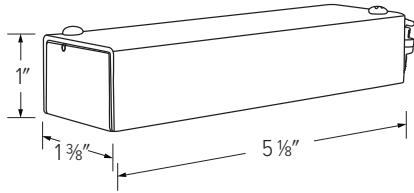

Fits through ceiling hole. Electronic Low Voltage (ELV) dimmable 12V AC output, 120V Input. 60W Daisy chain up to 6 Oak Fixtures on one transformer.

LET-60 / LET-60-277 SIDE FEED ELECTRONIC TRANSFORMER

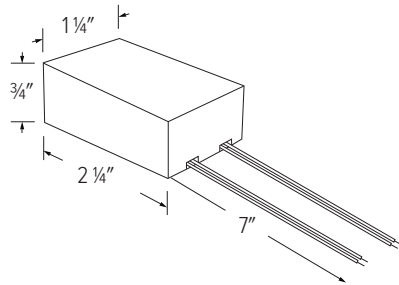

LET-60H BOTTOM FEED ELECTRONIC TRANSFORMER

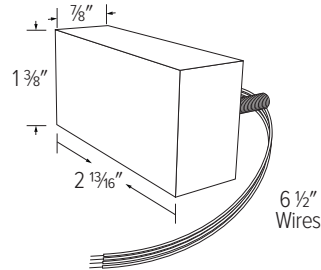

Electronic Low Voltage (ELV) dimmable (120V Only). 12V AC output. 60W. For remote installation. Daisy chain up to 6 Oak Fixtures on one transformer.

LET-60DX / LET-60DX-277 ELECTRONIC TRANSFORMER

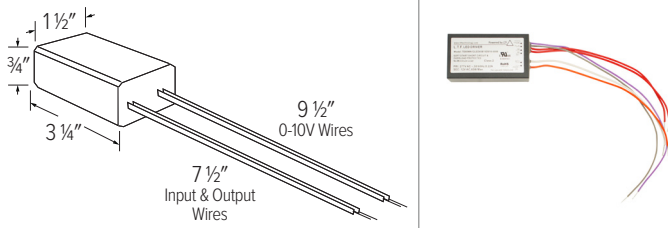

0-10V dimmable. 12V AC output. 60W. For remote installation. Daisy chain up to 6 Oak Fixtures on one transformer.

ETR-12 / ETR-12-20 MAGNETIC TRANSFORMER

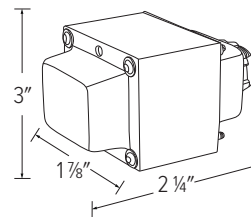

Magnetic Low Voltage (MLV) dimmable. 12V AC output, 120V input. For remote installation.

PRODUCT DIMENSIONS

OAK™ OPTIONAL FRAMES

Optional Frames for Oak™ Downlights				
E1LF1 SINGLE	E1LF1-M2 2 Sets	E1LF1-M3 3 Sets	E1LF1-M4 4 Sets	E1LF1-M5 5 Sets
<p>E1LF1-M2: A = 8 3/4" E1LF1-M3: A = 13" E1LF1-M4: A = 17 1/2" E1LF1-M5: A = 21 3/4"</p>				

Optional Frames for Oak™ Adjustables				
E1LF2 SINGLE	E1LF2-M2 2 Sets	E1LF2-M3 3 Sets	E1LF2-M4 4 Sets	E1LF2-M5 5 Sets
<p>E1LF2-M2: A = 8 3/4" E1LF2-M3: A = 13" E1LF2-M4: A = 17 1/2" E1LF2-M5: A = 21 3/4"</p>				

Optional Frames for Oak™ Trimless				
E2LF1 SINGLE	E1LF2-M2 2 Sets	E1LF2-M3 3 Sets	E1LF2-M4 4 Sets	E1LF2-M5 5 Sets
<p>E1LF1-M2: A = 8 3/4" E1LF1-M3: A = 13" E1LF1-M4: A = 17 1/2" E1LF1-M5: A = 21 3/4"</p>				

OAK™ LIGHT ENGINES

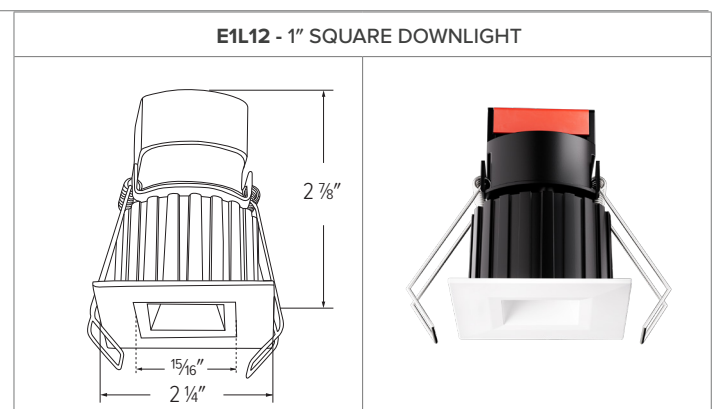
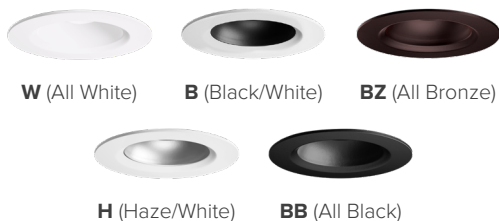

PRODUCT DIMENSIONS

OAK™ LIGHT ENGINES

E1L22 - 1" SQUARE PULL DOWN 30° ADJUSTABILITY

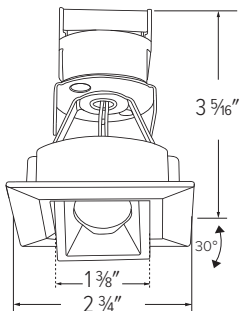

W (All White) **BZ** (All Bronze) **B** (All Black)

E1L32 - 1" ROUND GIMBAL 30° ADJUSTABILITY

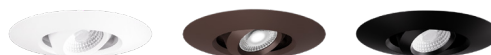
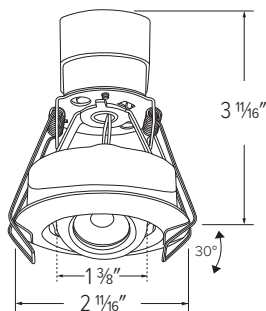

W (All White) **BZ** (All Bronze) **B** (All Black)

E1L61 - 1" ROUND TRIMLESS

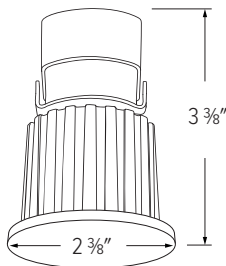

W (All White) **BZ** (All Bronze) **BB** (All Black)

ELOSFR - 1" TRIMLESS SPACKLE FRAME

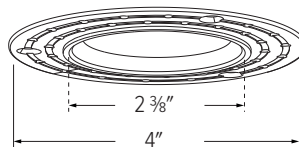



TRIMS (for use with E1L02 and E1L12 only)



RM1W (All White)	RM1B (Black/ White Ring)	RM1BZ (Bronze)	RM1H (Haze/ White Ring)	RM1BB (All Black)
RM11W (All White)	RM11B (Black/ White Ring)	RM11BZ (Bronze)	RM11H (Haze/ White Ring)	RM11BB (All Black)

ACCESSORIES

LENS & OPTICS (field changeable for E1L02, E1L12 & E1L32))

EP713C / EP714C / EP715C OPTIONAL LENS	L60 FROSTED DIFFUSER	L61 HEX LOUVER
		
13C (28°) / 14C (38°) / 15C (50°)	For a softer light	For a better glare shield

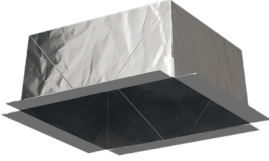
FIRE RATED PRODUCTS

FIREENCL / FIREENCL-S 1-HOUR FIRE ENCLOSURE FOR RECESSED FIXTURES	FIRETAPE MICA ADHESIVE FIRE TAPE FOR FIRE ENCLOSURE	FIRECVR 2-HOUR FIRE COVER FOR RECESSED FIXTURES
		
<p>Standard - 9" H x 20 3/8" L x 14 3/8" W Shallow (-S) - 7 1/4" H x 16" L x 14 3/8" W</p> <p>Provides fire barrier around recessed lights. ETL approved 1-hour fire rating. Meets UL 263, ASTM E119 Specifications. To be used with Mica Tape to seal the power feeding point. (FIRETAPE sold separately)</p>	<p>3/4" W x 16' L</p> <p>Fire proof mica adhesive tape helps seal the power feeding point on Fire Enclosure. Offers outstanding high temperature and flame resistance, and provides excellent electrical insulation.</p>	<p>9 3/4" H x 17" O.D. x 13" I.D.</p> <p>Made of heat activated intumescent material. UL approved for most ceiling types: sheetrock drywall, gypsum & acoustical tiles. UL Rated enclosure stops flame spread and heat transmission for up to 2 hours.</p>

TECHNICAL DETAILS

Optics: PC Lens for even lumen distribution. Standard 38° lens. Optional 28° (EP713C) and 50° (EP715C) available.

Adjustability: 360° rotation with 30° gimbal adjustability. Gimbal can be locked into place by tightening locking screw.

Construction: Diecast construction for lasting quality and greater heat dissipation. High quality powder coat finish prevents rust and paint cracking.

Installation: Requires 12V AC transformer. Height allows for use in ceilings with under 3" depth. Ceiling thickness can be reduced from fixture depth.

2" cutout for downlight (E1L02 & E1L12)

2 3/8" cutout for adjustable (E1L32 & E2L22)

2 1/2" cutout for trimless (EL01SFR + E1L61)

LED Technology: Extremely accurate color rendering with 93+ CRI. Efficacy of up to 110 lumens per watt. Lumen Maintenance of 50,000 hours L70 based on LM80. Superior Thermal Management by utilizing diecast aluminum body as heat sink.

Sunset: Sunset color temperature is our dim-to-warm LED technology that allows the color temperature to become warmer as the product is dimmed. Our SUNSET dim Oak items start at 3000K and go as low as 1800K when dimmed. For Sunset dim technology be sure to order an item with "Sunset SD" in the Color Temperature (CCT) attribute.

Electrical: Requires 12V AC transformer. Can be daisy chained up to 6 fixtures with E1LDRV60 or can be wired 1 fixture per transformer.

Delivered Lumens:

E1L02F E1L12F: 600 lm/2700K, 625 lm/3000K, 650 lm/3500K, 675 lm/4000K, 450 lm/Sunset

E1L22F & E1L32F: 625 lm/2700K, 650 lm/3000K, 675 lm/3500K, 700 lm/4000K

E1L61F: 600 lm/2700K, 625 lm/3000K, 650 lm/3500K, 675 lm/4000K, 450 lm/Sunset

Dimming: Dims with MLV dimmers when powered by dimmable magnetic 12V AC transformer. Works with ELV dimmers when powered by dimmable electronic 12V AC transformer. Dims with 0-10V systems with 0-10V dimmable 12V AC transformer. Check transformer and dimmer compatibility before installation.

Multi-Frame Spacing:

E1LF1-M2, E1LF2-M2: Minimum spacing required between the first and last frames is 8 3/4".

E1LF1-M3, E1LF2-M3: Minimum spacing required between the first and last frames is 13".

E1LF1-M4, E1LF2-M4: Minimum spacing required between the first and last frames is 17 1/2".

E1LF1-M5, E1LF2-M5: Minimum spacing required between the first and last frames is 21 3/4".

Listings: cUL Listed. Fixed downlights cUL Listed for WET Location. Adjustable cUL Listed for Damp location. UL Listed for direct contact with insulation. Fixed downlights Airtight per ASTM E-283. California Title 24 (JA8-2016-E).

Warranty: ELCO Products are built to last with a 5-year Limited warranty.

DIMMER COMPATIBILITY CHART

FOR REFERENCE ONLY

Testing conducted by ELCO Lighting is not a substitute for and does not imply certification by an independent laboratory or any other standards certification. Refer to manufacturer specifications for more detailed information on product certifications and standards. Consult the dimmer manufacturer prior to installation to ensure compatibility.

MANUFACTURER	PRODUCT	PART NUMBER	DIMMED LIGHT OUTPUT RANGE
ELV Dimming			
Leviton	SureSlide® 300W 3-Way Electronic Low Voltage Dimmer	6615-P0	10% - 100%
	Decora® 450W Single-Pole/3-Way Electronic Low Voltage Dimmer	DSE06-10Z	10% - 100%
	IllumaTech® 300W Single-Pole/3-Way Electronic Low Voltage Dimmer	IPE04-1LZ	10% - 100%
	Vizia® RF + 600W Single-Pole/3-Way/Multi-Location Electronic Low Voltage Dimmer	VRE06-1LZ	10% - 100%
	Vizia® 600W Single-Pole/3-Way/Multi-Location Electronic Low Voltage Dimmer	VZE06-1LX	10% - 100%
	Decora® Digital Bluetooth 600W Single-Pole/3-Way/Multi-Location Electronic Low Voltage Dimmer	DDE06-BLZ	10% - 100%
Lutron	Diva® 300W Single-Pole Electronic Low Voltage Dimmer	DVELV-300P	10% - 100%
	Diva® 300W 3-Way Electronic Low Voltage Dimmer	DVELV-303P	10% - 100%
	Skylark® 300W Single-Pole Electronic Low Voltage Dimmer	SELV-300P	10% - 100%
	Skylark® 300W 3-Way Electronic Low Voltage Dimmer	SELV-303P	10% - 100%
	Maestro® 600W Single-Pole/Multi-Location Electronic Low Voltage Dimmer	MAELV-600	10% - 100%

***NOTE: Refer to dimmer manufacturer's documentation for installation instructions and circuit details**

Disclaimer: Minimum and maximum loads for LEDs and CFLs are given in number of lamps and may vary depending on the lamp being used. Testing conducted by ELCO Lighting is not a substitute for and does not imply certification by an independent laboratory or any other standards certification. Refer to manufacturer specifications for more detailed information on product certifications and standards.

Integrating our lighting with your Smart Home System is a breeze. Simply check your Smart Home system for compatible smart switches and cross reference that with our Dimming Compatibility Chart.

Once the switches are integrated with your Smart Home system your lights will be ready to go.



1" RECESSED OAK™ LED LIGHT ENGINE

PHOTOMETRIC REPORT	CANDLE POWER SUMMARY		ILLUMINANCE AT A DISTANCE		
Product: E1L02F27 Wattage/Lumens: 6.23W / 627.5 lm Luminaire LPW: 100 lm/W	Degree Vertical	0°	Distance to Target Plane	Center Beam Footcandles	Beam Diameter
	0	1256	4'	78.5	2.8'
	5	1215	6'	34.9	4.2'
	15	845	8'	19.6	5.6'
	25	365	10'	12.6	6.9'
	35	101	ZONAL LUMEN SUMMARY		
	45	31			
	55	13	Zone	Lumens	%Luminaire
	65	7	0-30°	509.0	81.2
	75	4	0-40°	576.4	91.9
	85	1	0-60°	614.2	98
	90	0	0-90°	627.0	100

PHOTOMETRIC REPORT	CANDLE POWER SUMMARY		ILLUMINANCE AT A DISTANCE		
Product: E1L02F30 Wattage/Lumens: 6W / 600 lm Luminaire LPW: 100 lm/W	Degree Vertical	0°	Distance to Target Plane	Center Beam Footcandles	Beam Diameter
	0	1315	4'	113	2.8'
	5	1272	6'	40.0	4.2'
	15	884	8'	20.5	5.6'
	25	382	10'	14.1	6.9'
	35	106	ZONAL LUMEN SUMMARY		
	45	33			
	55	14	Zone	Lumens	%Luminaire
	65	8	0-30°	532.8	81.2
	75	4	0-40°	603.4	91.9
	85	1	0-60°	642.9	98
	90	0	0-90°	656.4	100

PHOTOMETRIC REPORT	CANDLE POWER SUMMARY		ILLUMINANCE AT A DISTANCE		
Product: E1L02NF30 Wattage/Lumens: 6.3W / 642 lm Luminaire LPW: 101 lm/W	Degree Vertical	0°	Distance to Target Plane	Center Beam Footcandles	Beam Diameter
	0	2492	4'	156	1.7'
	5	2207	6'	69.2	2.6'
	15	922	8'	38.93	.5'
	25	257	10'	24.94	.4'
	35	62	ZONAL LUMEN SUMMARY		
	45	19			
	55	7	Zone	Lumens	%Luminaire
	65	4	0-30°	570.3	88.9
	75	2	0-40°	612.6	95.5
	85	0	0-60°	634.7	98.9
	90	0	0-90°	641.6	100

PHOTOMETRIC REPORT	CANDLE POWER SUMMARY		ILLUMINANCE AT A DISTANCE		
Product: E1L02F35 Wattage/Lumens: 6.23W / 678.1 lm Luminaire LPW: 108 lm/W	Degree Vertical	0°	Distance to Target Plane	Center Beam Footcandles	Beam Diameter
	0	1357	4'	84.8	2.8'
	5	1312	6'	37.7	4.2'
	15	912	8'	21.2	5.6'
	25	394	10'	13.6	6.9'
	35	109	ZONAL LUMEN SUMMARY		
	45	34			
	55	15	Zone	Lumens	%Luminaire
	65	8	0-30°	549.7	81.2
	75	4	0-40°	622.5	91.9
	85	1	0-60°	663.3	98
	90	0	0-90°	677.2	100

1" RECESSED OAK™ LED LIGHT ENGINE

PHOTOMETRIC REPORT	CANDLE POWER SUMMARY		ILLUMINANCE AT A DISTANCE		
	Degree Vertical	0°	Distance to Target Plane	Center Beam Footcandles	Beam Diameter
Product: E1L02F40 Wattage/Lumens: 6.23W / 679.3 lm Luminaire LPW: 109 lm/W	0	1361	4'	85.1	2.8'
	5	1316	6'	37.8	4.2'
	15	915	8'	21.3	5.6'
	25	395	10'	13.6	6.9'
	35	110	ZONAL LUMEN SUMMARY		
	45	34			
	55	15	Zone	Lumens	%Luminaire
	65	8	0-30°	551.4	81.2
	75	4	0-40°	624.5	91.9
	85	1	0-60°	665.4	98
	90	0	0-90°	679.3	100

PHOTOMETRIC REPORT	CANDLE POWER SUMMARY		ILLUMINANCE AT A DISTANCE		
	Degree Vertical	0°	Distance to Target Plane	Center Beam Footcandles	Beam Diameter
Product: E1L02FSD Wattage/Lumens: 6.23W / 600 lm Luminaire LPW: 96 lm/W	0	821	4'	51.3	2.8'
	5	794	6'	22.8	4.2'
	15	552	8'	12.8	5.6'
	25	238	10'	8.21	6.9'
	35	66	ZONAL LUMEN SUMMARY		
	45	20			
	55	9	Zone	Lumens	%Luminaire
	65	5	0-30°	332.5	81.2
	75	3	0-40°	376.5	91.9
	85	0	0-60°	401.2	98
	90	0	0-90°	409.6	100

PHOTOMETRIC REPORT	CANDLE POWER SUMMARY		ILLUMINANCE AT A DISTANCE		
	Degree Vertical	0°	Distance to Target Plane	Center Beam Footcandles	Beam Diameter
Product: E1L12F27 Wattage/Lumens: 6.3W / 600 lm Luminaire LPW: 95 lm/W	0	1218	4'	76.2	2.7'
	5	1186	6'	33.8	4.0'
	15	812	8'	19.0	5.4'
	25	309	10'	12.2	6.7'
	35	89	ZONAL LUMEN SUMMARY		
	45	30			
	55	17	Zone	Lumens	%Luminaire
	65	10	0-30°	484.4	79.8
	75	5	0-40°	547.9	90.3
	85	0	0-60°	590.9	97.3
	90	0	0-90°	607.0	100

PHOTOMETRIC REPORT	CANDLE POWER SUMMARY		ILLUMINANCE AT A DISTANCE		
	Degree Vertical	0°	Distance to Target Plane	Center Beam Footcandles	Beam Diameter
Product: E1L12F30 Wattage/Lumens: 6W / 600 lm Luminaire LPW: 100 lm/W	0	1269	4'	79.3	2.7'
	5	1235	6'	35.3	4.0'
	15	846	8'	19.8	5.3'
	25	322	10'	12.7	6.7'
	35	93	ZONAL LUMEN SUMMARY		
	45	31			
	55	18	Zone	Lumens	%Luminaire
	65	10	0-30°	504.7	79.8
	75	5	0-40°	570.7	90.3
	85	0	0-60°	615.6	97.3
	90	0	0-90°	632.4	100

1" RECESSED OAK™ LED LIGHT ENGINE

PHOTOMETRIC REPORT	CANDLE POWER SUMMARY		ILLUMINANCE AT A DISTANCE		
	Degree Vertical	0°	Distance to Target Plane	Center Beam Footcandles	Beam Diameter
Product: E1L12F35 Wattage/Lumens: 6.4W / 656.2 lm Luminaire LPW: 102 lm/W	0	1316	4'	82.3	2.7'
	5	1281	6'	36.6	4.0'
	15	877	8'	20.6	5.4'
	25	334	10'	13.2	6.7'
	35	96	ZONAL LUMEN SUMMARY		
	45	33			
	55	18	Zone	Lumens	%Luminaire
	65	11	0-30°	523.3	79.8
	75	5	0-40°	591.8	90.3
	85	0	0-60°	638.3	97.3
	90	0	0-90°	655.7	100

PHOTOMETRIC REPORT	CANDLE POWER SUMMARY		ILLUMINANCE AT A DISTANCE		
	Degree Vertical	0°	Distance to Target Plane	Center Beam Footcandles	Beam Diameter
Product: E1L12F40 Wattage/Lumens: 6.3W / 674.8 lm Luminaire LPW: 107 lm/W	0	1355	4'	84.7	2.7'
	5	1318	6'	37.6	4.0'
	15	903	8'	21.2	5.4'
	25	343	10'	13.5	6.7'
	35	99	ZONAL LUMEN SUMMARY		
	45	34			
	55	19	Zone	Lumens	%Luminaire
	65	11	0-30°	538.5	79.8
	75	5	0-40°	609.0	90.3
	85	1	0-60°	656.9	97.3
	90	0	0-90°	674.8	100

PHOTOMETRIC REPORT	CANDLE POWER SUMMARY		ILLUMINANCE AT A DISTANCE		
	Degree Vertical	0°	Distance to Target Plane	Center Beam Footcandles	Beam Diameter
Product: E1L12FSD Wattage/Lumens: 6.3W / 600 lm Luminaire LPW: 95 lm/W	0	850	4'	53.2	2.7'
	5	828	6'	23.6	4.0'
	15	567	8'	13.3	5.4'
	25	216	10'	8.50	6.7'
	35	62	ZONAL LUMEN SUMMARY		
	45	21			
	55	12	Zone	Lumens	%Luminaire
	65	7	0-30°	338.1	79.8
	75	3	0-40°	382.4	90.3
	85	0	0-60°	412.4	97.3
	90	0	0-90°	423.7	100

PHOTOMETRIC REPORT	CANDLE POWER SUMMARY		ILLUMINANCE AT A DISTANCE		
	Degree Vertical	0°	Distance to Target Plane	Center Beam Footcandles	Beam Diameter
Product: E1L22F27 Wattage/Lumens: 6.4W / 637.5 lm Luminaire LPW: 99 lm/W	0	1250	4'	78.1	2.8'
	5	1208	6'	34.7	4.2'
	15	835	8'	19.5	5.6'
	25	354	10'	12.5	7.0'
	35	104	ZONAL LUMEN SUMMARY		
	45	37			
	55	12	Zone	Lumens	%Luminaire
	65	6	0-30°	508.3	79.8
	75	3	0-40°	583.7	91.7
	85	0	0-60°	627.1	98.5
	90	0	0-90°	636.7	100

1" RECESSED OAK™ LED LIGHT ENGINE

PHOTOMETRIC REPORT	CANDLE POWER SUMMARY		ILLUMINANCE AT A DISTANCE		
	Degree Vertical	0°	Distance to Target Plane	Center Beam Footcandles	Beam Diameter
Product: E1L22F30 Wattage/Lumens: 6.4W / 600 lm Luminaire LPW: 93.7 lm/W	0	1302	4'	81.4	2.8'
	5	1259	6'	36.2	4.2'
	15	869	8'	20.3	5.6'
	25	368	10'	13.0	7.0'
	35	108	ZONAL LUMEN SUMMARY		
	45	39			
	55	13	Zone	Lumens	%Luminaire
	65	6	0-30°	529.5	88.3
	75	3	0-40°	608.0	91.7
	85	0	0-60°	653.2	98.5
	90	0	0-90°	663.2	100

PHOTOMETRIC REPORT	CANDLE POWER SUMMARY		ILLUMINANCE AT A DISTANCE		
	Degree Vertical	0°	Distance to Target Plane	Center Beam Footcandles	Beam Diameter
Product: E1L22F40 Wattage/Lumens: 6.4W / 708.3 lm Luminaire LPW: 110 lm/W	0	1390	4'	86.9	2.8'
	5	1344	6'	38.6	4.2'
	15	929	8'	21.7	5.6'
	25	393	10'	13.9	7.0'
	35	116	ZONAL LUMEN SUMMARY		
	45	41			
	55	14	Zone	Lumens	%Luminaire
	65	7	0-30°	565.5	79.8
	75	3	0-40°	649.3	91.7
	85	0	0-60°	697.6	98.5
	90	0	0-90°	708.3	100

PHOTOMETRIC REPORT	CANDLE POWER SUMMARY		ILLUMINANCE AT A DISTANCE		
	Degree Vertical	0°	Distance to Target Plane	Center Beam Footcandles	Beam Diameter
Product: E1L32F27 Wattage/Lumens: 6.25W / 632.8 lm Luminaire LPW: 101.2 lm/W	0	1266	4'	79.1	2.8'
	5	1225	6'	35.2	4.2'
	15	852	8'	19.2	5.6'
	25	368	10'	12.7	6.9'
	35	102	ZONAL LUMEN SUMMARY		
	45	31			
	55	14	Zone	Lumens	%Luminaire
	65	7	0-30°	513.0	81.2
	75	4	0-40°	581.0	91.9
	85	1	0-60°	619.1	98
	90	0	0-90°	632.0	100

PHOTOMETRIC REPORT	CANDLE POWER SUMMARY		ILLUMINANCE AT A DISTANCE		
	Degree Vertical	0°	Distance to Target Plane	Center Beam Footcandles	Beam Diameter
Product: E1L32F30 Wattage/Lumens: 6.2W / 600 lm Luminaire LPW: 96 lm/W	0	1319	4'	82.4	2.8'
	5	1276	6'	36.6	4.2'
	15	887	8'	20.6	5.6'
	25	383	10'	13.2	6.9'
	35	106	ZONAL LUMEN SUMMARY		
	45	33			
	55	14	Zone	Lumens	%Luminaire
	65	8	0-30°	534.4	81.2
	75	4	0-40°	605.2	91.9
	85	1	0-60°	644.9	98
	90	0	0-90°	658.4	100

1" RECESSED OAK™ LED LIGHT ENGINE

PHOTOMETRIC REPORT	CANDLE POWER SUMMARY		ILLUMINANCE AT A DISTANCE		
	Degree Vertical	0°	Distance to Target Plane	Center Beam Footcandles	Beam Diameter
Product #: E1L32F35 Wattage / Lumens: 6.25 W / 692.1 lm Luminaire LPW: 110.7 lm/W	0	1385	4'	163	2.8'
	5	1340	6'	35.5	4.2'
	15	931	8'	21.6	5.6'
	25	402	10'	13.8	6.9'
	35	112	ZONAL LUMEN SUMMARY		
	45	34			
	55	15	Zone	Lumens	%Luminaire
	65	8	0-30°	561.1	82.2
	75	4	0-40°	635.5	91.9
	85	1	0-60°	677.1	98
	90	0	0-90°	691.3	100

PHOTOMETRIC REPORT	CANDLE POWER SUMMARY		ILLUMINANCE AT A DISTANCE		
	Degree Vertical	0°	Distance to Target Plane	Center Beam Footcandles	Beam Diameter
Product #: E1L32F40 Wattage / Lumens: 6.25 W / 708 lm Luminaire LPW: 113.2 lm/W	0	1418	4'	88.7	2.8'
	5	1372	6'	39.4	4.2'
	15	954	8'	22.2	5.6'
	25	412	10'	14.2	6.9'
	35	114	ZONAL LUMEN SUMMARY		
	45	35			
	55	15	Zone	Lumens	%Luminaire
	65	8	0-30°	574.7	81.2
	75	5	0-40°	650.9	91.9
	85	1	0-60°	693.5	98
	90	0	0-90°	708.0	100

PHOTOMETRIC REPORT	CANDLE POWER SUMMARY		ILLUMINANCE AT A DISTANCE		
	Degree Vertical	0°	Distance to Target Plane	Center Beam Footcandles	Beam Diameter
Product: E1L61F27 Wattage/Lumens: 6.23W / 627.5 lm Luminaire LPW: 100 lm/W	0	1256	4'	78.5	2.8'
	5	1215	6'	34.9	4.2'
	15	845	8'	19.6	5.6'
	25	365	10'	12.6	6.9'
	35	101	ZONAL LUMEN SUMMARY		
	45	31			
	55	13	Zone	Lumens	%Luminaire
	65	7	0-30°	509.0	81.2
	75	4	0-40°	576.4	91.9
	85	1	0-60°	614.2	98
	90	0	0-90°	627.0	100

PHOTOMETRIC REPORT	CANDLE POWER SUMMARY		ILLUMINANCE AT A DISTANCE		
	Degree Vertical	0°	Distance to Target Plane	Center Beam Footcandles	Beam Diameter
Product: E1L61F30 Wattage/Lumens: 6.23W / 656.4 lm Luminaire LPW: 105 lm/W	0	1315	4'	82.2	2.8'
	5	1272	6'	36.5	4.2'
	15	884	8'	20.5	5.6'
	25	382	10'	13.2	6.9'
	35	106	ZONAL LUMEN SUMMARY		
	45	33			
	55	14	Zone	Lumens	%Luminaire
	65	8	0-30°	532.8	81.2
	75	4	0-40°	603.4	91.9
	85	1	0-60°	642.9	98
	90	0	0-90°	656.4	100

1" RECESSED OAK™ LED LIGHT ENGINE

PHOTOMETRIC REPORT	CANDLE POWER SUMMARY		ILLUMINANCE AT A DISTANCE		
	Degree Vertical	0°	Distance to Target Plane	Center Beam Footcandles	Beam Diameter
Product: E1L61F35 Wattage/Lumens: 6.23W / 678.1 lm Luminaire LPW: 108 lm/W	0	1357	4'	84.8	2.8'
	5	1312	6'	37.7	4.2'
	15	912	8'	21.2	5.6'
	25	394	10'	13.6	6.9'
	35	109	ZONAL LUMEN SUMMARY		
	45	34			
	55	15	Zone	Lumens	%Luminaire
	65	8	0-30°	549.7	81.2
	75	4	0-40°	622.5	91.9
	85	1	0-60°	663.3	98
	90	0	0-90°	677.2	100

PHOTOMETRIC REPORT	CANDLE POWER SUMMARY		ILLUMINANCE AT A DISTANCE		
	Degree Vertical	0°	Distance to Target Plane	Center Beam Footcandles	Beam Diameter
Product: E1L61F40 Wattage/Lumens: 6.23W / 679.3 lm Luminaire LPW: 109 lm/W	0	1361	4'	85.1	2.8'
	5	1316	6'	37.8	4.2'
	15	915	8'	21.3	5.6'
	25	395	10'	13.6	6.9'
	35	110	ZONAL LUMEN SUMMARY		
	45	34			
	55	15	Zone	Lumens	%Luminaire
	65	8	0-30°	551.4	81.2
	75	4	0-40°	624.5	91.9
	85	1	0-60°	665.4	98
	90	0	0-90°	679.3	100

PHOTOMETRIC REPORT	CANDLE POWER SUMMARY		ILLUMINANCE AT A DISTANCE		
	Degree Vertical	0°	Distance to Target Plane	Center Beam Footcandles	Beam Diameter
Product: E1L61FSD Wattage/Lumens: 6.23W / 600 lm Luminaire LPW: 96 lm/W	0	821	4'	51.3	2.8'
	5	794	6'	22.8	4.2'
	15	552	8'	12.8	5.6'
	25	238	10'	8.21	6.9'
	35	66	ZONAL LUMEN SUMMARY		
	45	20			
	55	9	Zone	Lumens	%Luminaire
	65	5	0-30°	332.5	81.2
	75	3	0-40°	376.5	91.9
	85	0	0-60°	401.2	98
	90	0	0-90°	409.6	100