

# 3" KOTO™ MAX DOWNLIGHTING SYSTEM

6W-32W, 2700K-4000K, Up to 3500 lm, 120-277V

## THE KOTO™ MAX SYSTEM

The high quality commercial grade downlight engineered to be shallow, taking less space than a regular recessed housing. With a lumen output up to 3,500 lumen, the module offers maximum flexibility, providing designers and architects with the necessary choices when laying out a project.



### FEATURES

- Driver on frame:  
120-277V, 0-10V/Triac/ELV dimming to 1%
- 18°, 25°, 38°, 60°, and 90° beam angle options
- Excellent color rendering 95+ CRI
- Title 24 JA8-2022 E-Compliant. ENERGY STAR Certified
- Covered by U.S. PATENTS and Patents Pending

### SET UP

1. Select a Frame or Remodel/Retrofit power pack.
2. Select a Koto™ MAX Module.
3. Select a Trim.

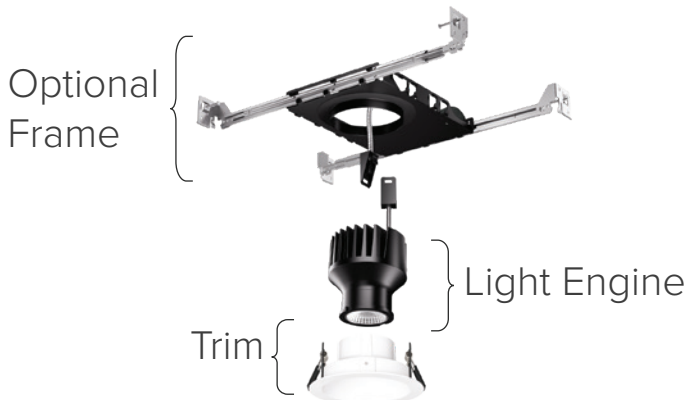

### SPECIFICATIONS

Wattage	6W - 32W
Lumens	750 lm - 3500 lm
Voltage	120-277V
Color Temp.	2700K, 3000K, 3500K or 4000K
CRI	95+
Damp Location	UL Listed Adjustable Trims
Wet Location	UL Listed Fixed Trims
Dimming	0-10V/Triac/ELV (1%)
Beam Angle	18°, 25°, 38°, 60° & 90°

Finishes	Color
<input type="checkbox"/>	White
<input type="checkbox"/>	Black
<input type="checkbox"/>	Bronze
<input type="checkbox"/>	Black/ White
<input type="checkbox"/>	Chrome/ White
<input type="checkbox"/>	Haze/ White

## PRODUCT NUMBER BUILDER

### 1. Specify housing part number

#### 3" KOTO™ MAX NEW CONSTRUCTION FRAMES

FRAMES Example: E3CKTAF25DX

ITEM	SIZE/STYLE	FRAME	LUMEN/WATTAGE	VOLTAGE/DIMMING	EM OPTIONAL
<b>E</b>					
<b>E</b>	<b>3CKT</b> 3" New Construction	<b>(Blank)</b> Plaster Frame <sup>2</sup>	<b>07</b> 750 lm / 6W <sup>4</sup>	<b>DX</b> 120-277V, 0-10V/Triac/ELV (1%)	<b>(Blank)</b> No EM
		<b>AF</b> Architectural Frame <sup>3</sup>	<b>10</b> 1000 lm / 8W <sup>4</sup>		
	<b>CKTRM</b> Remodel/Retrofit <sup>1</sup>	—	<b>12</b> 1250 lm / 11W <sup>4</sup>		
			<b>15</b> 1500 lm / 14W <sup>4</sup>		
			<b>20</b> 2000 lm / 19W <sup>5</sup>		
			<b>25</b> 2500 lm / 23W <sup>5</sup>		
			<b>30</b> 3000 lm / 29W <sup>5</sup>		
	<b>35</b> 3500 lm / 32W <sup>5</sup>				
	<sup>1</sup> Remodel is available up to 2500 lm, works with all size trims, no frame.	<sup>2</sup> Includes Hanger Bars. <sup>3</sup> Hanger bars ordered separately. <b>FB27</b> - 27" Flat bars for wood construction. <b>CH26</b> - 26" C-Channel bars for T-Bar ceiling.	<sup>4</sup> IC rated for direct contact with insulation, cUL up to 1500 lumens (14W). <sup>5</sup> Non IC, for use without insulation, or keep insulation 3" away from fixture. 2000 (19W) - 3500 (32W) lumens.		

### 2. Specify Koto™ LED Module part number (Select one)

#### KOTO™ MAX LED MODULE

KOTO™ MAX MODULE Example: ECKT3527D-S

ITEM	COLOR TEMPERATURE	BEAM ANGLE
<b>ECKT35</b>		
<b>ECKT35<sup>1</sup></b>	<b>27D</b> 2700K	<b>(Blank)</b> 38° <sup>2</sup>
	<b>30D</b> 3000K	<b>-S</b> 18°
	<b>35D</b> 3500K	<b>-N</b> 25°
	<b>40D</b> 4000K	<b>-W</b> 60°
		<b>-E</b> 90°
<sup>1</sup> ECKT35 module works with all Koto™ MAX housings & trims, for all sizes & lumen outputs.		<sup>2</sup> 38° installed on module with 25° & 60° included in the box.

## PRODUCT NUMBER BUILDER

### 3. Specify trim part number

## 3" KOTO™ CANLESS TRIMS

### ROUND TRIMS



Style: **Fixed Deep Reflector**  
Item: **EKCL3618W** (All White)  
**EKCL3618BB** (All Black)  
**EKCL3618BZ** (All Bronze)  
**EKCL3618B** (Black/White Ring)  
**EKCL3618C** (Chrome/White Ring)  
**EKCL3618H** (Haze/White Ring)



Style: **Adjustable Reflector**  
Item: **EKCL3629W** (All White)  
**EKCL3629BB** (All Black)  
**EKCL3629BZ** (All Bronze)  
**EKCL3629B** (Black/White Ring)  
**EKCL3629C** (Chrome/White Ring)  
**EKCL3629H** (Haze/White Ring)



Style: **Adjustable Pinhole**  
Item: **EKCL3627W** (All White)  
**EKCL3627BB** (All Black)  
**EKCL3627BZ** (All Bronze)  
**EKCL3627B** (Black/White Ring)



Style: **Adjustable Slot Aperture**  
Item: **EKCL3620W** (Black Slot/White Ring)



Style: **Adjustable Reflector Wall Wash**  
Item: **EKCL3622W** (All White)



Style: **Directional Gimbal**  
Item: **EKCL3679W** (All White)  
**EKCL3679BB** (All Black)  
**EKCL3679B** (Black/White Ring)  
**EKCL3679H** (Haze/White Ring)



Style: **Micro Flange Reflector**  
Item: **EKCL3663W** (All White)  
**EKCL3663BB** (All Black)



Style: **Curved Reflector**  
Item: **EKCL3672W** (All White)  
**EKCL3672B** (All Black)

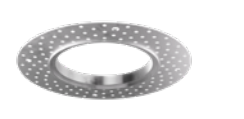

Style: **Flush Mount Spackle Frame**  
Item: **EL3FMR**  
Compatible with EKCL3618, EKCL3629, EKCL3627, EKCL3620, & EKCL3622 trims only

### SQUARE TRIMS



Style: **Fixed Deep Reflector**  
Item: **EKCL3318W** (All White)  
**EKCL3318BB** (All Black)  
**EKCL3318BZ** (All Bronze)  
**EKCL3318B** (Black/White Ring)  
**EKCL3318C** (Chrome/White Ring)  
**EKCL3318H** (Haze/White Ring)



Style: **Adjustable Reflector**  
Item: **EKCL3329W** (All White)  
**EKCL3329BB** (All Black)  
**EKCL3329BZ** (All Bronze)  
**EKCL3329B** (Black/White Ring)  
**EKCL3329C** (Chrome/White Ring)  
**EKCL3329H** (Haze/White Ring)



Style: **Adjustable Pinhole**  
Item: **EKCL3327W** (All White)  
**EKCL3327BB** (All Black)  
**EKCL3327BZ** (All Bronze)  
**EKCL3327B** (Black/White Ring)



Style: **Adjustable Reflector Wall Wash**  
Item: **EKCL3322W** (All White)



Style: **Square Reflector**  
Item: **EKCL3341W** (All White)  
**EKCL3341BB** (All Black)  
**EKCL3341BZ** (All Bronze)  
**EKCL3341B** (Black/White Ring)

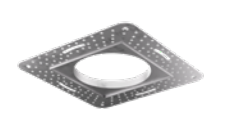

Style: **Flush Mount Spackle Frame**  
Item: **EL3FMS**  
Compatible with EKCL3318, EKCL3329, EKCL3327, EKCL3622, & EKCL3341 trims

---

## PRODUCT NUMBER BUILDER

---

### 3. Specify trim part number

---

## 3" KOTO™ CANLESS TRIMLESS

---

### ROUND TRIMLESS

---



Style: **Fixed Trimless Reflector**

Item: **ELK308W** (All White)  
**ELK308B** (All Black)  
**ELK308H** (All Haze)



Style: **Adjustable Trimless Reflector**

Item: **ELK315W** (All White)  
**ELK315B** (All Black)  
**ELK315H** (All Haze)



Style: **Trimless Spackle Frame**

Item: **EL3SFR**  
For use with ELK308 & ELK315



Style: **Knife Edge Wood Ceiling Adaptor**

Item: **EL3WCRW** (All White)  
**EL3WCRB** (All Black)  
For use with ELK308 & ELK315

## PRODUCT DIMENSIONS

### KOTO™ MAX FRAMES AND REMODEL/RETROFIT POWER PACK

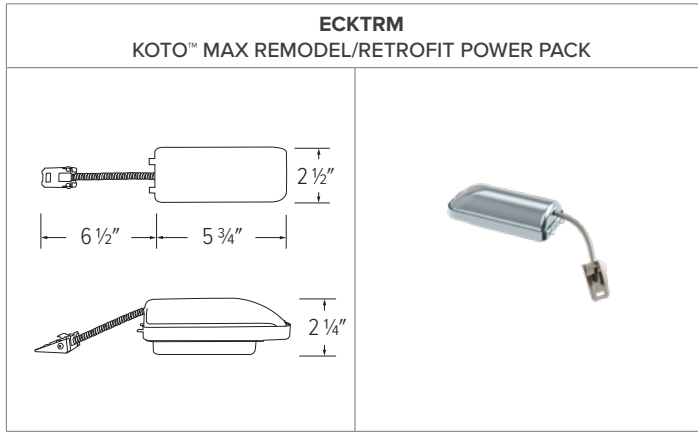
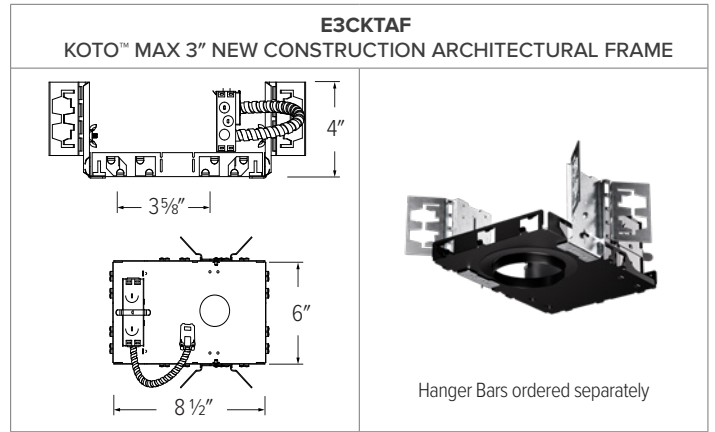
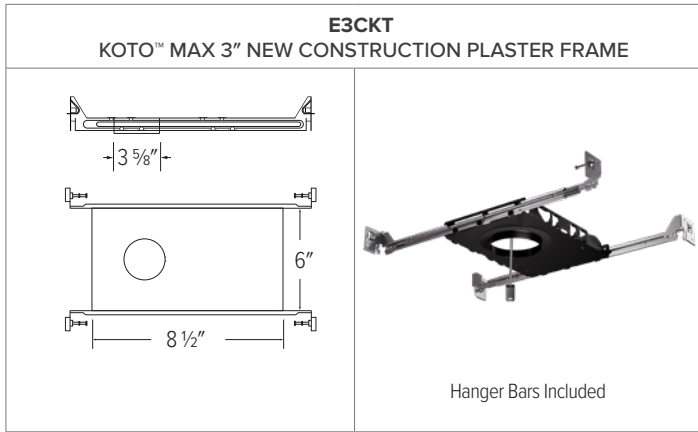

### Hanger Bars for **Koto™ MAX** Architectural Frames

27" Flat Hanger Bars  
for Wood Construction  
(Set of 2)

**FB27**

26" C-Channel  
Hanger Bars for  
T-Bar Ceilings (Set of 2)

**CH26**

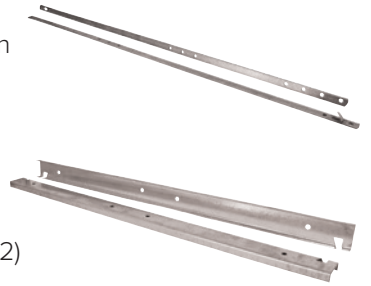

### KOTO™ MAX LED LIGHT ENGINE



# PRODUCT DIMENSIONS

## KOTO™ CANLESS ROUND TRIMS

**EKCL3618 - 3" ROUND DEEP REFLECTOR**

3"  
4 3/8"

5" Height (Trim + Module)

NET LOCATION

**EKCL3629 - 3" ROUND ADJUSTABLE REFLECTOR**

3"  
4 3/8"

4 1/8" Height (Trim + Module)  
360° Rotation - 30° Tilt

DAMP LOCATION



**EKCL3627 - 3" ROUND ADJUSTABLE PINHOLE**

1 3/4"  
4 3/8"

4 1/8" Height (Trim + Module)  
360° Rotation - 30° Tilt

DAMP LOCATION

**EKCL3620 - 3" ROUND ADJUSTABLE SLOT APERTURE**

4 3/8"

4 1/8" Height (Trim + Module)  
45° Tilt

DAMP LOCATION



**EKCL3622 - 3" ADJUSTABLE REFLECTOR WALL WASH**

3"  
4 3/8"

4 3/4" Height (Trim + Module)  
45° Tilt

DAMP LOCATION

**EKCL3679 - 3" ROUND DIRECTIONAL GIMBAL**

3"  
4 3/8"

3 7/8" Height (Trim + Module)  
360° Rotation - 25° Tilt

DAMP LOCATION

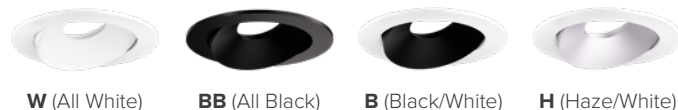

## PRODUCT DIMENSIONS

### KOTO™ CANLESS ROUND TRIMS

#### EKCL3663 - 3" ROUND MICRO FLANGE REFLECTOR

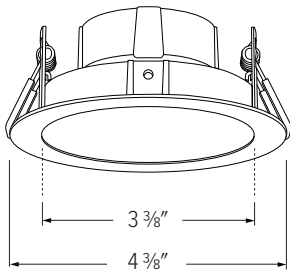

4 5/8" Height (Trim + Module)



**W** (All White)



**BB** (All Black)

#### EKCL3672 - 3" ROUND CURVED REFLECTOR

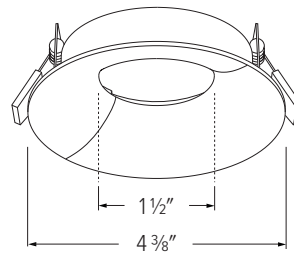

4" Height (Trim + Module)



**W** (All White)



**BB** (All Black)

#### EL3FMR - 3" ROUND FLUSH MOUNT SPACKLE FRAME

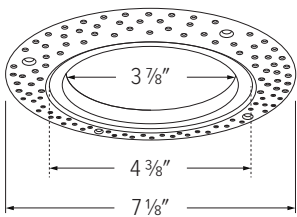

Compatible with EKCL3618, EKCL3629,  
EKCL3627, EKCL3620, & EKCL3622 trims

# PRODUCT DIMENSIONS

## KOTO™ CANLESS SQUARE TRIMS

**EKCL3318 - 3" SQUARE DEEP REFLECTOR**

5" Height (Trim + Module)

**EKCL3329 - 3" SQUARE ADJUSTABLE REFLECTOR**

4" Height (Trim + Module)  
358° Rotation - 30° Tilt



**EKCL3327 - 3" SQUARE ADJUSTABLE PINHOLE**

4 1/8" Height (Trim + Module)  
360° Rotation - 30° Tilt

**EKCL3322 - 3" SQUARE ADJUSTABLE REFLECTOR WALL WASH**

4 3/4" Height (Trim + Module)  
45° Tilt



**EKCL3341 - 3" SQUARE REFLECTOR**

4 3/8" Height (Trim + Module)

**EL3FMS - 3" SQUARE FLUSH MOUNT SPACKLE FRAME**

Compatible with EKCL3318, EKCL3329, EKCL3327, EKCL3322, & EKCL3341 trims





# PRODUCT DIMENSIONS

## KOTO™ CANLESS ROUND TRIMLESS

**ELK308 - 3" ROUND TRIMLESS REFLECTOR**

3"

4 1/2" Height (Trimless + Module)

WET LOCATION



**W** (All White)



**B** (All Black)



**H** (All Haze)

**ELK315 - 3" ROUND ADJUSTABLE TRIMLESS REFLECTOR**

3"

4 1/2" Height (Trimless + Module)  
35° Tilt

DAMP LOCATION



**W** (All White)



**B** (All Black)



**H** (All Haze)

**EL3SFR - 3" ROUND TRIMLESS SPACKLE FRAME**

3"

7 1/8"

For use with ELK308 & ELK315

**EL3WCRW - 3" ROUND KNIFE EDGE WOOD CEILING ADAPTOR**

3 3/16"

3 7/8"

For use with ELK308 & ELK315  
Compatible with ceiling up to 2" thick













**W** (All White)



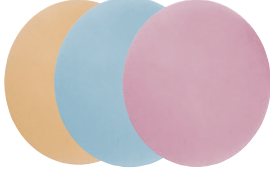

**B** (All Black)

## ACCESSORIES

### LENS & OPTICS (field changeable)

<b>EP731C / EP732C / EP733C / EP734C</b> LENS INCLUDED	<b>EP739C</b> OPTIONAL LENS	<b>L45 / L57</b> HEX LOUVER	<b>L46</b> LINEAR LENS	<b>L47</b> SPREAD LENS
				
31C (18°) / 32C (25°) / 33C (38°) / 34C (60°)	(90°)	L45 (Black) / L57 (White) For a better glare shield	For a wide rectangular illumination pattern	For a symmetrical broadening of light beams
<b>L49</b> FROSTED DIFFUSER	<b>L51 / L52 / L53</b> COLOR SHIFTERS	<b>L54</b> SINGLE ASYMMETRIC LENS	<b>L55</b> DOUBLE ASYMMETRIC LENS	<b>L50W / L50B</b> SNOOTS
				
For a softer light	L51 (Color temp. reducer) / L52 (Blue) / L53 (Pink)			L50W (White) / L50B (Black) Reduces glare and light spill

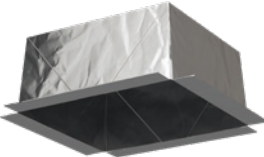
### FIRE RATED PRODUCTS

<b>FIREENCL / FIREENCL-S</b> 1-HOUR FIRE ENCLOSURE FOR RECESSED FIXTURES	<b>FIRETAPE</b> MICA ADHESIVE FIRE TAPE FOR FIRE ENCLOSURE	<b>FIRECVR</b> 2-HOUR FIRE COVER FOR RECESSED FIXTURES
		
<b>Standard</b> - 9" H x 20 3/8" L x 14 3/8" W <b>Shallow (-S)</b> - 7 1/4" H x 16" L x 14 3/8" W	3/4" W x 16' L	9 3/4" H x 17" O.D. x 13" I.D.
Provides fire barrier around recessed lights. ETL approved 1-hour fire rating. Meets UL 263, ASTM E119 Specifications. To be used with Mica Tape to seal the power feeding point. (FIRETAPE sold separately)	Fire proof mica adhesive tape helps seal the power feeding point on Fire Enclosure. Offers outstanding high temperature and flame resistance, and provides excellent electrical insulation.	Made of heat activated intumescent material. UL approved for most ceiling types: sheetrock drywall, gypsum & acoustical tiles. UL Rated enclosure stops flame spread and heat transmission for up to 2 hours.

### EMERGENCY BATTERY BACKUP

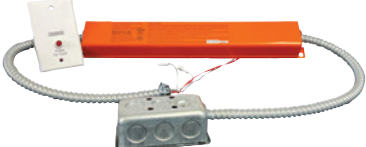
<p align="center"><b>KEM-ERT</b> EMERGENCY BATTERY BACKUP</p>

<b>KEM-ERT</b> 90 minutes of emergency operation. Input: 100-277VAC, 50/60Hz., 25W Max Output: 170VDC, 25W Charging time: 36 hours Suitable for damp location cUL listed

---

## TECHNICAL DETAILS

---

**Optics:** PC lens diffuses light evenly throughout while reducing glare with LED COB technology.

**Construction:** IC rated for direct contact with insulation for 750 lm (6W), 1000 lm (8W), 1250 lm (11W) & 1500 lm (14W) outputs. Non IC rated for 2000 lm (19W), 2500 lm (23W), 3000 lm (29W), & 3500 lm (32W) outputs.

**Construction (Light Engine):** Diecast aluminum body with heat fins allow for efficient cooling.

**Installation (Frame):** High strength hanger bars can easily be nailed to joists. Suitable for T-grid and drop ceiling applications. See installation sheet for detailed information.

**Hanger Bars:** Pre-installed hanger bars with True Nail easy installation in regular lumber, engineered lumber, and laminated beams. Integral T-bar slots for easy installation in T-bars. Spans up 24" and can be repositioned 90°. Score lines allow for tool-free hanger bar size reduction. Integral leveling flange allows for single-person installation while easily aligning the housings with the joists.

Hanger bars ordered separately for Architectural Frame. 27" Flat bars for wood construction (FB27) and 26" C-Channel bars for T-bar ceiling (CH26) available.

**Installation (Light Engine):** Twist-On design for tool-less trim installation, for use with Canless Koto™ trims only. Can be used with New Construction Plaster and Architectural Frames or Remodel/Retrofit Koto™ MAX Power Pack.

**LED Technology:** Extremely accurate Color Rendering Index (CRI) of 95+. Lumen Maintenance of 50,000 hours L70 Life span based on LM80 standardized test results. Superior Thermal Management by utilizing integrated heat sink. Instant On to Full Brightness technology. No LED pixelation.

**Electrical:** Driver is rated for 120-277V input. High Efficiency driver with a power factor >0.95.

**Dimming:** Triac/ELV/0-10V dimming (1%)

**Emergency Battery Pack:** Optional 25W MAX. 90 minute battery backup 2", 3", 4" & 6" accessible from below.

**Listings:** cUL Listed for Damp Location with Damp Location trims and Wet Location with Wet Location trims. IC Rated for direct contact with insulation up to 14W. Non-IC for 19W-32W. Light engine is thermally protected. RoHS Compliant. Title 24 JA8-2022 E-Compliant.

**Warranty:** ELCO Products are built to last with a 5-year Limited warranty.

## DIMMER COMPATIBILITY CHART

### FOR REFERENCE ONLY

Testing conducted by ELCO Lighting is not a substitute for and does not imply certification by an independent laboratory or any other standards certification. Refer to manufacturer specifications for more detailed information on product certifications and standards. Consult the dimmer manufacturer prior to installation to ensure compatibility.

MANUFACTURER	PRODUCT	PART NUMBER	DIMMED LIGHT OUTPUT RANGE
<b>120V - Triac/ELV Dimmers for E2CKT Series, E2CKTAF Series, E2CKTRM Series, E3CKT Series, E3CKTAF Series, E3CKTRM Series, E4CKT Series, E4CKTAF Series, E4CKTRM Series, E6CKT Series, E6CKTAF Series, E6CKTRM Series</b>			
Leviton	120V AC 60Hz, 300W Electronic Low Voltage, 400 Volt Amp, Single Pole, 3-Way	IPE04	1% - 100%
	120V AC 60Hz, 300W CFL or 600W Incandescent, 400 Volt Amp, Single Pole, 3-Way	6673-10W	1% - 100%
	120V AC, 600W Incandescent with LED Locator, Single Pole, 3-Way	VP106	1% - 100%
	120V AC 60Hz, 500W Incandescent with LED Level Indicator, Single Pole, 3-Way	6161	1% - 100%
	120V AC, 150W LED/CFL or 600W Incandescent, Single Pole, 3-Way	6674	1% - 100%
Lutron	120V AC, 150W LED/CFL or 600W Incandescent/Halogen, Single Pole, 3-Way	RRD-6CL	1% - 100%
	120V AC 60Hz, 150W LED/CFL/Incandescent/Halogen, Single Pole, 3-Way	DVCL-153P	1% - 100%
	120V 60Hz, 150W LED/CFL or 600W Incandescent/Halogen, Single Pole, 3-Way	TGCL-153P	1% - 100%
	120V AC 60Hz, 300W Electronic Low Voltage, 3-Way, Commercial/Residential Application	DVELV-303P	1% - 100%
	120V, 600W Incandescent/Halogen, Single Pole, Residential Indoor Application	TG-600P	1% - 100%
	120V, 1000W Incandescent or 600W Magnetic Low Voltage, Single Pole, 3-Way	CT103P	1% - 100%
	120V AC 60Hz, 600W Electronic Low Voltage, Single Pole/Multi-Location	MAELV600	1% - 100%
	120V AC 60Hz, 500W Electronic Low Voltage, Single Pole/Multi-Location	FAELV500	1% - 100%
	120V AC 60Hz, 600W Incandescent/Halogen, Single Pole, Slide-to-Off Dimmer	S-600P	1% - 100%
	120V AC 60Hz, 150W LED/CFL or 600W Incandescent/Halogen, Single Pole, 3-Way	SCL-153P	1% - 100%
	Caséta® Wireless Dimmer	PD-6WCL	1% - 100%
	120V AC 60Hz, Low Voltage Load Type, 150W Single Pole	DVLV-600P	5% - 100%
	120V AC, 60Hz, 600W Incandescent/Halogen, Single Pole, 3-Way, Residential and Commercial Application	DV-603P	1% - 100%
	120V AC, 50/60Hz, 150W LED/CFL, 600W Incandescent/Halogen, Single Pole, 3-Way, Indoor Application	MA-PRO	1% - 100%
120V AC 60Hz, 150W LED/CFL or 600W Incandescent/Halogen, Single Pole, 3-Way	MACL-153M	1% - 100%	
Eaton	120V AC, 300W LED/CFL or 600W Incandescent/MLV/Halogen, Single Pole, 3-Way	TAL06P1-C1	1% - 100%
Cooper	120V AC 60Hz, 300W LED/CFL or 600W Incandescent/Halogen, Single Pole, 3-Way	SLC03P / DAL06P	1% - 100%
	120V AC 60Hz, 300W LED/CFL or 600W Incandescent, Single Pole, 3-Way, Residential	DLC03P	1% - 100%
	120V AC 60Hz, 600W Incandescent/Halogen, Single Pole, 3-Way	RI061-VW-K2	1% - 100%
	120V AC 60Hz, 300W LED/CFL/ Incandescent/Halogen, Single Pole, 3-Way	AAL06A-C2	1% - 100%
Lightolier	120V, 260W Incandescent/Halogen, Single Pole, 3-Way	ZP260QEW	1% - 100%

<b>0-10V Type Dimmers - 120/277V for E2CKT Series, E2CKTAF Series, E2CKTRM Series, E3CKT Series, E3CKTAF Series, E3CKTRM Series, E4CKT Series, E4CKTAF Series, E4CKTRM Series, E6CKT Series, E6CKTAF Series, E6CKTRM Series</b>			
Lutron	120/277V AC, 0-10V LED/CFL Ballast, Single Pole, 3-Way	NFTV	1% - 100%
	120/277V AC, 0-10V, Single Pole, 3-Way, Commercial and Residential, Indoor Application	DVSTV	1% - 100%
	120/277V AC 50/60Hz, 0-10V LED/CFL Ballast, Single Pole, 3-Way, Indoor Application	DVTV	1% - 100%
Leviton	120/277V AC 60Hz, 0-10V LED/CFL Ballast, Single Pole, 3-Way	IP710-DL	1% - 100%

**\*NOTE: Refer to dimmer manufacturer's documentation for installation instructions and circuit details**

Disclaimer: Minimum and maximum loads for LEDs and CFLs are given in number of lamps and may vary depending on the lamp being used. Testing conducted by ELCO Lighting is not a substitute for and does not imply certification by an independent laboratory or any other standards certification. Refer to manufacturer specifications for more detailed information on product certifications and standards.

Integrating our lighting with your Smart Home System is a breeze. Simply check your Smart Home system for compatible smart switches and cross reference that with our Dimming Compatibility Chart. Once the switches are integrated with your Smart Home system your lights will be ready to go.



# KOTO™ MAX LED MODULE

PHOTOMETRIC REPORT	CANDLE POWER SUMMARY		ILLUMINANCE AT A DISTANCE		
<b>Product #:</b> ECKT3530D (EXCKT07DX) <b>Wattage / Lumens:</b> 5.83W / 736.6 lm <b>Luminaire LPW:</b> 126.35 lm/W	Degree Vertical	0°	Distance to Target Plane	Center Beam Footcandles	Beam Diameter
	0	2047	4'	128	2.3'
	5	1987	6'	56.9	3.4'
	15	1279	8'	32.0	4.5'
	25	434	10'	20.5	5.7'
	35	78	<b>ZONAL LUMEN SUMMARY</b>		
	45	34			
	55	23	Zone	Lumens	%Luminaire
	65	13	0-30°	629.3	85.5
	75	6	0-40°	672.8	91.4
	85	2	0-60°	716.1	97.3
	90	2	0-90°	735.9	100

PHOTOMETRIC REPORT	CANDLE POWER SUMMARY		ILLUMINANCE AT A DISTANCE		
<b>Product #:</b> ECKT3530D (EXCKT10DX) <b>Wattage / Lumens:</b> 7.44W / 996.7 lm <b>Luminaire LPW:</b> 133.97 lm/W	Degree Vertical	0°	Distance to Target Plane	Center Beam Footcandles	Beam Diameter
	0	2656	4'	166	2.3'
	5	2639	6'	73.8	3.4'
	15	1745	8'	41.5	4.6'
	25	638	10'	26.6	5.7'
	35	116	<b>ZONAL LUMEN SUMMARY</b>		
	45	44			
	55	30	Zone	Lumens	%Luminaire
	65	16	0-30°	849.6	85.3
	75	7	0-40°	915.4	91.9
	85	2	0-60°	972.0	97.6
	90	2	0-90°	995.8	100

PHOTOMETRIC REPORT	CANDLE POWER SUMMARY		ILLUMINANCE AT A DISTANCE		
<b>Product #:</b> ECKT3530D (EXCKT12DX) <b>Wattage / Lumens:</b> 10.11W / 1250.5 lm <b>Luminaire LPW:</b> 123.69 lm/W	Degree Vertical	0°	Distance to Target Plane	Center Beam Footcandles	Beam Diameter
	0	3389	4'	212	2.3
	5	3047	6'	94.2	3.4
	15	1678	8'	53.0	4.6
	25	415	10'	33.9	5.7
	35	93	<b>ZONAL LUMEN SUMMARY</b>		
	45	53			
	55	39	Zone	Lumens	%Luminaire
	65	26	0-30°	1,033.0	82.6
	75	16	0-40°	1,107.6	88.6
	85	13	0-60°	1,192.2	95.4
	90	12	0-90°	1,249.9	100

PHOTOMETRIC REPORT	CANDLE POWER SUMMARY		ILLUMINANCE AT A DISTANCE		
<b>Product #:</b> ECKT3530D (EXCKT15DX) <b>Wattage / Lumens:</b> 12.89W / 1499.5 lm <b>Luminaire LPW:</b> 116.33 lm/W	Degree Vertical	0°	Distance to Target Plane	Center Beam Footcandles	Beam Diameter
	0	4067	4'	254	2.3
	5	3657	6'	113	3.4
	15	2013	8'	63.6	4.6
	25	498	10'	40.7	5.7
	35	112	<b>ZONAL LUMEN SUMMARY</b>		
	45	64			
	55	47	Zone	Lumens	%Luminaire
	65	31	0-30°	1,239.6	82.6
	75	19	0-40°	1,329.1	88.6
	85	15	0-60°	1,430.7	95.4
	90	14	0-90°	1,499.9	100

# KOTO™ MAX LED MODULE

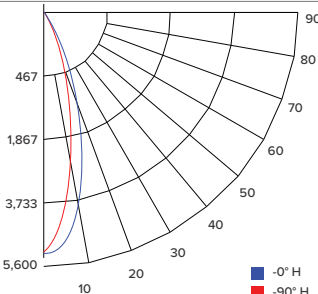
PHOTOMETRIC REPORT	CANDLE POWER SUMMARY		ILLUMINANCE AT A DISTANCE		
	Degree Vertical	0°	Distance to Target Plane	Center Beam Footcandles	Beam Diameter
<b>Product #: ECKT3530D (EXCKT20DX)</b> Wattage / Lumens: 18.3W / 1992 lm Luminaire LPW: 108.85 lm/W  	0	5310	4'	332	2.2
	5	5026	6'	148	3.3
	15	3081	8'	83.0	4.4
	25	985	10'	53.1	5.5
	35	190	<b>ZONAL LUMEN SUMMARY</b>		
	45	94			
	55	67	Zone	Lumens	%Luminaire
	65	40	0-30°	1,665.0	83.6
	75	21	0-40°	1,794.8	90.1
	85	12	0-60°	1,920.3	96.4
90	12	0-90°	1,991.3	100	

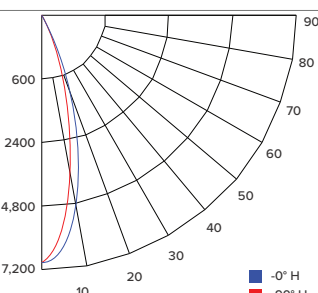
PHOTOMETRIC REPORT	CANDLE POWER SUMMARY		ILLUMINANCE AT A DISTANCE		
	Degree Vertical	0°	Distance to Target Plane	Center Beam Footcandles	Beam Diameter
<b>Product #: ECKT3530D (EXCKT25DX)</b> Wattage / Lumens: 21.76W / 2547.9 lm Luminaire LPW: 117.09 lm/W  	0	7057	4'	441	2.3
	5	6670	6'	196	3.4
	15	4097	8'	110	4.5
	25	1282	10'	70.6	5.6
	35	242	<b>ZONAL LUMEN SUMMARY</b>		
	45	116			
	55	82	Zone	Lumens	%Luminaire
	65	50	0-30°	2,158.0	84.7
	75	26	0-40°	2,309.7	90.7
	85	14	0-60°	2,464.4	96.7
90	14	0-90°	2,547.0	100	

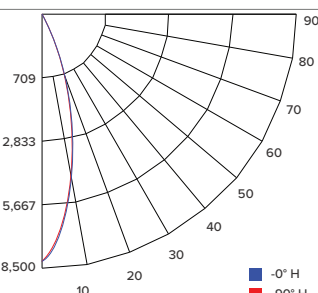
PHOTOMETRIC REPORT	CANDLE POWER SUMMARY		ILLUMINANCE AT A DISTANCE		
	Degree Vertical	0°	Distance to Target Plane	Center Beam Footcandles	Beam Diameter
<b>Product #: ECKT3530D (EXCKT30DX)</b> Wattage / Lumens: 28.6W / 2997.8 lm Luminaire LPW: 104.82 lm/W  	0	8295	4'	518	2.3
	5	7488	6'	230	3.4
	15	4204	8'	130	4.5
	25	1168	10'	82.9	5.7
	35	233	<b>ZONAL LUMEN SUMMARY</b>		
	45	132			
	55	91	Zone	Lumens	%Luminaire
	65	51	0-30°	2,548.4	85
	75	23	0-40°	2,723.7	90.9
	85	13	0-60°	2,904.1	96.9
90	12	0-90°	2,996.9	100	

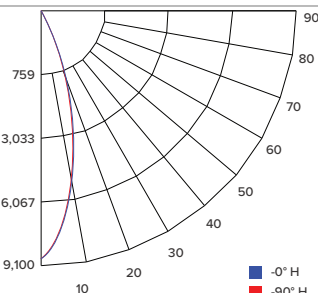
PHOTOMETRIC REPORT	CANDLE POWER SUMMARY		ILLUMINANCE AT A DISTANCE		
	Degree Vertical	0°	Distance to Target Plane	Center Beam Footcandles	Beam Diameter
<b>Product #: ECKT3530D (EXCKT35DX)</b> Wattage / Lumens: 31.55W / 3212.8 lm Luminaire LPW: 101.83 lm/W  	0	8887	4'	555	2.3
	5	8023	6'	247	3.4
	15	4504	8'	139	4.5
	25	1252	10'	88.9	5.7
	35	250	<b>ZONAL LUMEN SUMMARY</b>		
	45	141			
	55	98	Zone	Lumens	%Luminaire
	65	54	0-30°	2,730.5	85
	75	25	0-40°	2,918.2	90.9
	85	14	0-60°	3,111.5	96.9
90	13	0-90°	3,211.0	100	

# KOTO™ MAX LED MODULE

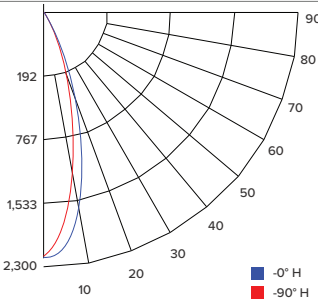
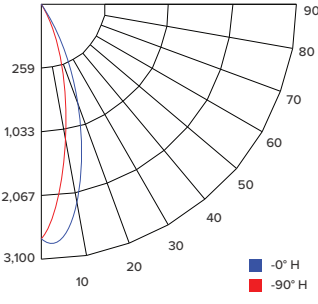
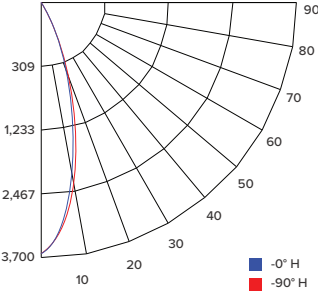
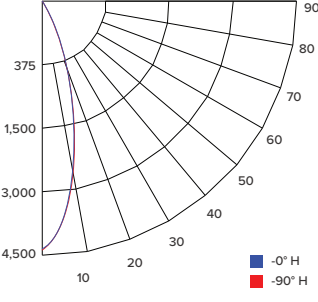
PHOTOMETRIC REPORT	CANDLE POWER SUMMARY		ILLUMINANCE AT A DISTANCE		
<b>Product #:</b> ECKT3540D (EXCKT07DX) <b>Wattage / Lumens:</b> 5.83W / 795.8 lm <b>Luminaire LPW:</b> 136.5 lm/W 	Degree Vertical	0°	Distance to Target Plane	Center Beam Footcandles	Beam Diameter
	0	2211	4'	138	2.3
	5	2146	6'	61.4	3.4
	15	1381	8'	34.5	4.5
	25	468	10'	22.1	5.7
	35	84	<b>ZONAL LUMEN SUMMARY</b>		
	45	36			
	55	25	Zone	Lumens	%Luminaire
	65	14	0-30°	679.6	85.5
	75	6	0-40°	726.6	91.4
85	3	0-60°	773.4	97.3	
90	2	0-90°	794.7	100	
<b>Product #:</b> ECKT3540D (EXCKT10DX) <b>Wattage / Lumens:</b> 7.44W / 1076.6 lm <b>Luminaire LPW:</b> 144.7 lm/W 	Degree Vertical	0°	Distance to Target Plane	Center Beam Footcandles	Beam Diameter
	0	2868	4'	179	2.3
	5	2850	6'	79.7	3.4
	15	1884	8'	44.8	4.6
	25	690	10'	28.7	5.7
	35	125	<b>ZONAL LUMEN SUMMARY</b>		
	45	48			
	55	33	Zone	Lumens	%Luminaire
	65	18	0-30°	917.6	85.3
	75	7	0-40°	988.6	91.9
85	3	0-60°	1,049.8	97.6	
90	2	0-90°	1,075.5	100	
<b>Product #:</b> ECKT3540D (EXCKT12DX) <b>Wattage / Lumens:</b> 10.11W / 1350.5 lm <b>Luminaire LPW:</b> 133.58 lm/W 	Degree Vertical	0°	Distance to Target Plane	Center Beam Footcandles	Beam Diameter
	0	3661	4'	229	2.3
	5	3291	6'	102	3.4
	15	1812	8'	57.2	4.6
	25	448	10'	36.6	5.7
	35	101	<b>ZONAL LUMEN SUMMARY</b>		
	45	57			
	55	42	Zone	Lumens	%Luminaire
	65	28	0-30°	1,115.6	82.6
	75	17	0-40°	1,196.2	88.6
85	14	0-60°	1,287.6	95.4	
90	13	0-90°	1,349.9	100	
<b>Product #:</b> ECKT3540D (EXCKT15DX) <b>Wattage / Lumens:</b> 12.89W / 1619.6 lm <b>Luminaire LPW:</b> 125.65 lm/W 	Degree Vertical	0°	Distance to Target Plane	Center Beam Footcandles	Beam Diameter
	0	4393	4'	275	2.3
	5	3949	6'	122	3.4
	15	2174	8'	68.6	4.6
	25	538	10'	43.9	5.7
	35	121	<b>ZONAL LUMEN SUMMARY</b>		
	45	69			
	55	50	Zone	Lumens	%Luminaire
	65	34	0-30°	1,338.7	82.6
	75	20	0-40°	1,435.4	88.6
85	16	0-60°	1,545.1	95.4	
90	16	0-90°	1,619.9	100	

# KOTO™ MAX LED MODULE

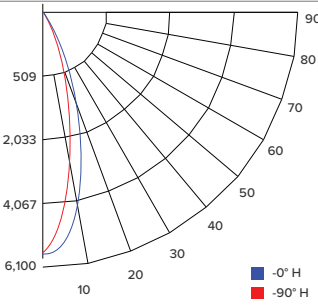
PHOTOMETRIC REPORT	CANDLE POWER SUMMARY		ILLUMINANCE AT A DISTANCE		
<b>Product #:</b> ECKT3540D (EXCKT20DX) <b>Wattage / Lumens:</b> 18.3W / 2151.9 lm <b>Luminaire LPW:</b> 117.59 lm/W 	Degree Vertical	0°	Distance to Target Plane	Center Beam Footcandles	Beam Diameter
	0	5735	4'	358	2.2
	5	5428	6'	159	3.3
	15	3328	8'	89.6	4.4
	25	1063	10'	57.3	5.5
	35	205	<b>ZONAL LUMEN SUMMARY</b>		
	45	101			
	55	72	Zone	Lumens	%Luminaire
	65	43	0-30°	1,798.2	83.6
	75	23	0-40°	1,938.4	90.1
85	13	0-60°	2,073.9	96.4	
90	13	0-90°	2,150.6	100	

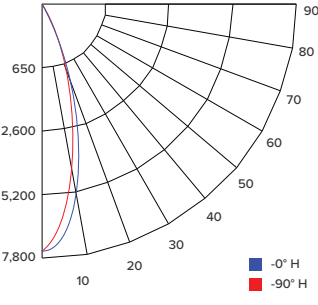
PHOTOMETRIC REPORT	CANDLE POWER SUMMARY		ILLUMINANCE AT A DISTANCE		
<b>Product #:</b> ECKT3540D (EXCKT25DX) <b>Wattage / Lumens:</b> 21.76W / 2751.7 lm <b>Luminaire LPW:</b> 126.46 lm/W 	Degree Vertical	0°	Distance to Target Plane	Center Beam Footcandles	Beam Diameter
	0	7621	4'	476	2.3
	5	7204	6'	212	3.4
	15	4424	8'	119	4.5
	25	1385	10'	76.2	5.6
	35	261	<b>ZONAL LUMEN SUMMARY</b>		
	45	126			
	55	89	Zone	Lumens	%Luminaire
	65	54	0-30°	2,330.6	84.7
	75	28	0-40°	2,494.4	90.7
85	16	0-60°	2,661.5	96.7	
90	15	0-90°	2,750.8	100	

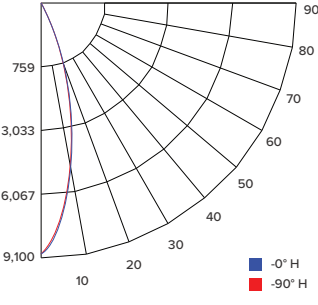
PHOTOMETRIC REPORT	CANDLE POWER SUMMARY		ILLUMINANCE AT A DISTANCE		
<b>Product #:</b> ECKT3540D (EXCKT30DX) <b>Wattage / Lumens:</b> 28.6W / 3237.6 lm <b>Luminaire LPW:</b> 113.20 lm/W 	Degree Vertical	0°	Distance to Target Plane	Center Beam Footcandles	Beam Diameter
	0	8958	4'	560	2.3
	5	8087	6'	249	3.4
	15	4540	8'	140	4.5
	25	1262	10'	89.6	5.7
	35	252	<b>ZONAL LUMEN SUMMARY</b>		
	45	142			
	55	98	Zone	Lumens	%Luminaire
	65	55	0-30°	2,752.3	85
	75	25	0-40°	2,941.6	90.9
85	14	0-60°	3,136.4	96.9	
90	13	0-90°	3,236.7	100	

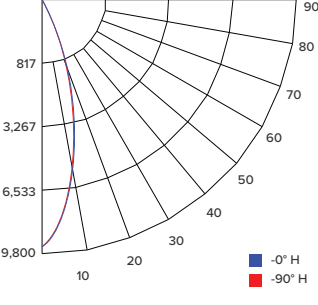
PHOTOMETRIC REPORT	CANDLE POWER SUMMARY		ILLUMINANCE AT A DISTANCE		
<b>Product #:</b> ECKT3540D (EXCKT35DX) <b>Wattage / Lumens:</b> 31.55W / 3469.9 lm <b>Luminaire LPW:</b> 109.99 lm/W 	Degree Vertical	0°	Distance to Target Plane	Center Beam Footcandles	Beam Diameter
	0	9598	4'	600	2.3
	5	8665	6'	267	3.4
	15	4865	8'	150	4.5
	25	1352	10'	96	5.7
	35	270	<b>ZONAL LUMEN SUMMARY</b>		
	45	153			
	55	105	Zone	Lumens	%Luminaire
	65	59	0-30°	2,948.9	85
	75	27	0-40°	3,151.7	90.9
85	15	0-60°	3,360.4	96.9	
90	14	0-90°	3,467.9	100	