

9" New Construction Architectural Frame with Driver



Features

- Optional 90 minutes, 120/277 VAC, 60Hz Emergency Backup.
- USA designed and assembled.
- LED Light Engine and Hanger bars sold separately (see Compatible Products).

Specifications

Lumens	3000 lm
Voltage	120/277V
Dimmable	Triac/ELV/0-10V
Power Factor	≥0.9
Damp Location	Listed

Options



Optional EM Battery Back-up

Technical Details

Construction:

Constructed from 16 gauge galvanized steel for large architectural applications. Housing adjusts in frame to accommodate up to 2" ceiling thickness.

Installation:

Designed for architectural buildings. Easily installed with hanger bars (ordered separately for specific application type). Light engine installed into frame.

Junction Box: Positioned to accommodate straight conduit runs. Seven 1/2" trade size conduit knockouts and four pry-out knockout slots for easy romex installation.

Hanger Bars: Hanger bars ordered separately as FB27: Set of two 27" hanger bars for wood construction or CH26: Set of two 26" C-Channel hanger bars for T-Bar Ceiling.

Electrical:

- Driver is rated for 120V and 277V input (120/277V).
- High Efficiency driver with a power factor > 0.9.
- Can be specified with Lutron drivers for specific applications.

Dimmability:

- 3 in 1 dimming: Triac, ELV and 0-10V dimming in one driver.
- 0-10V dimming down to 5% with a compatible dimmer.
- Flicker-Free Dimming.
- Can be specified with Lutron drivers for 0.1% and 1% dimming.
- For a full list of dimmers refer to the Dimmer Compatibility List.

Listings: cULus Listed for Damp Location. cULus Listed for Wet Location with select trims. cULus Listed for Direct Contact with Insulation and Combustible Material for units up to 2000 lm. cULus Listed for Feed Through. ENERGY STAR® Certified.

Warranty: ELCO Products are built to last. 5-year Limited warranty.

Dimensions

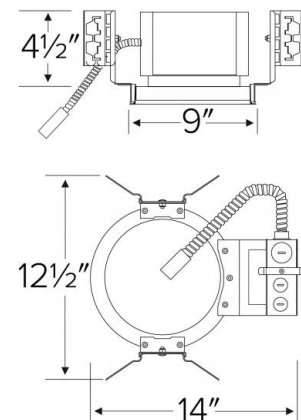

Product Number

Item	Lumens	Voltage	Dimming
E9LHU30D	3000 lm	120/277V	Triac/ELV/0-10V

Product Number Builder

Example: **E9LHU08D**

ELCO Laurel 9" Architectural Frame	Voltage	Lumens	Dimming	Optional
E9LH	<input type="text"/> U 120/277V	<input type="text"/> 08 850 lm 12 1250 lm 16 1600 lm 20 2000 lm 30 3000 lm 40 4000 lm 60 6000 lm	<input type="text"/> D Triac/ELV/0-10V S Sunset L Lutron	<input type="text"/> No EM EM1 8W Emer. Backup EM2 12W Emer. Backup

For use with 9" Laurel™ Frames

9" Laurel™ Commercial LED Light Engines

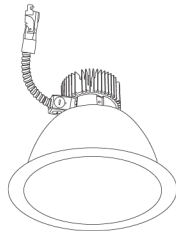

E910L
Reflector Trim

PRODUCT NUMBER BUILDER

Laurel™ Trim	Lumen	Color Temperature	Finish	Beam Angle
<input type="text"/>	<input type="text"/>	<input type="text"/>	<input type="text"/>	<input type="text"/>
E910L Reflector	08 850 lm	27 2700K	H All Haze	(blank) 60°
	12 1250 lm	30 3000K	W All White	-F 36°
	16 1600 lm	35 3500K	B All Black	-N 25°
	20 2000lm	40 4000K	C All Chrome	-S 10°
	30 3000lm	SD Sunset Dimming	HW Haze w/White Ring	
	40 4000lm			
	60 6000lm			