

Mini LED Floodlight

Mini LED floodlights are ideal for illuminating building facades, wall washing building exteriors, sign lighting, landscape lighting, and improving building security. Heavy-duty die-cast aluminum construction and high quality components ensure ELCO floodlights will provide years of solid performance in almost any weather condition.



Features

- Die-cast Aluminum Housing.
- Durable dark bronze coat finish.
- Knuckle mount for mounting on junction boxes or pipes.
- Trunnion mount for mounting on buildings, walls or flat surfaces.
- Standard input wattage: 15W (50W metal halide equivalent).

Specifications

Wattage	15W
Lumens	1600 lm
Voltage	120/277V
Color Temp.	5000K
Lamp Type	LED
CRI	75+
Power Factor	> 0.9
Wet Location	Listed

Options



Knuckle Mount



Trunnion Mount

Technical Details

Lamp: Array LED, CRI 75+

Optics: Polycarbonate lens

Construction: Die-cast aluminum housing. Dark bronze powder coated finish. Impact, corrosion, and UV resistant

Electrical: Constant current 120/277V AC Class 2 Driver with a power factor > 0.9. Ambient operating temperature: -40°F (-40°C) to 113°F (45°C). Standard input wattage: 15W (50W metal halide equivalent)

Listings: cUL listed for wet locations. LM-80 certified. IP65 rated.

Warranty: ELCO Lighting warrants products will be free from defects in materials and workmanship for a period of 5 years

Dimensions

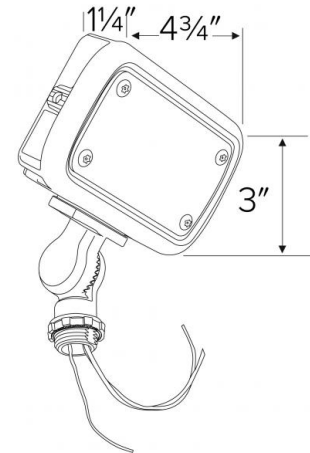

Trunnion Mount

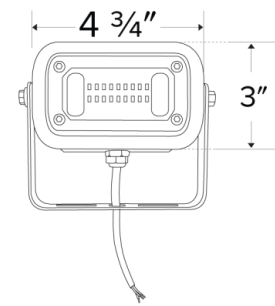

Product Number

Item	Lamp type	Lumens	CCT	Watts	Voltage	Finish
EFL15S50WFT	LED	1600 lm	5000K	15W	120/277V	Dark Bronze

Product Number Builder Example: EFL15S40WFK

Mini LED Floodlight	Wattage	Size	Color Temp	Mounting Type
EFL	15 15W	S Small	40 4000K 50 5000K	WFK Knuckle WFT Trunnion

Mini LED Floodlight

PHOTOMETRIC REPORT

Product #: EFL15S40WF
 Wattage/Lumens: 14.9W/ 1494 Lm
 Luminaire LPW: 100 Lm/W

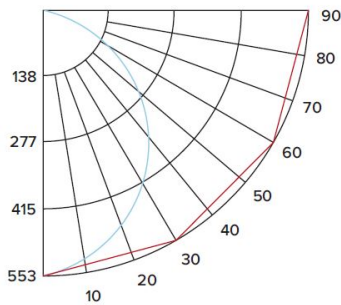

CANDLE POWER SUMMARY

Degrees Vertical	0°
0	551
5	544
15	508
25	445
35	368
45	286
55	205
65	132
75	73
85	21
90	4

ILLUMINANCE AT A DISTANCE

Distance to Target Plane	Footcandles Beam Center	Beam Diameter
4'	34.4	8.0'
6'	15.3	12.0'
8'	8.61	16.0'
10'	5.51	20.0'

ZONAL LUMEN SUMMARY

Zone	Lumens	% Luminaire
0-30°	426.92	28.60
0-40°	696.03	46.60
0-60°	1203.26	80.60
0-90°	1484.27	99.40

Mini LED Floodlight

PHOTOMETRIC REPORT

Product #: EFL15S50WF
 Wattage/Lumens: 15.1W/ 1575 Lm
 Luminaire LPW: 104 Lm/W

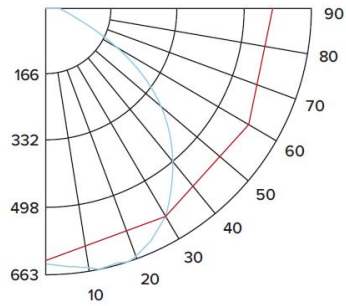

CANDLE POWER SUMMARY

Degrees Vertical	0°
0	635
5	622
15	589
25	515
35	413
45	302
55	209
65	135
75	67
85	22
90	6

ILLUMINANCE AT A DISTANCE

Distance to Target Plane	Footcandles Beam Center	Beam Diameter
4'	39.7	7.8'
6'	17.6	11.7'
8'	9.92	15.6'
10'	6.35	19.5'

ZONAL LUMEN SUMMARY

Zone	Lumens	% Luminaire
0-30°	502.22	31.90
0-40°	816.35	51.80
0-60°	1333.72	84.70
0-90°	1574.63	100.00