

LED Wall Mount with Photocell

The LED wall mount fixture is designed for safety and security in residential, stairway, storage, and perimeter lighting applications. Features a photocell and a powerful LED array for maximum energy efficiency. For applications requiring 1600 to 2700 lumens.



Features

- Die-cast Aluminum Housing.
- Durable dark bronze coat finish.
- Built in photocell.
- For mounting over electrical box or directly to the wall (surface conduit supply).
- Standard input wattage: 17W (120W incandescent equivalent) or 25W (50W HID equivalent).

Specifications

Wattage	25W
Lumens	2600 lm
Voltage	120/277V
Color Temp.	3000K
Lamp Type	LED
CRI	80+
Power Factor	> 0.9
Wet Location	Listed

Dimensions

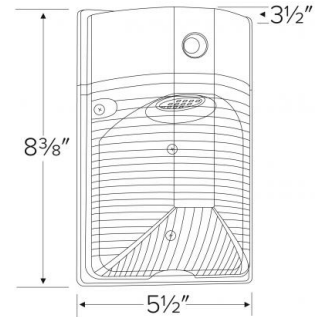

Technical Details

Lamp: Array LED, CRI 80+

Optics: Shatterproof polycarbonate

Construction: Die-cast aluminum housing. Impact, corrosion, and UV resistant.

Installation: 3/4" side and back knockouts for surface conduit supply. Mounts over a junction box or directly to a wall.

Electrical: Constant current 120V or 120/277V AC Class 2 Driver with a power factor > 0.9. Ambient operating temperature: -40°F (-40°C) to 113°F (45°C). Standard input wattage: 17W (120W incandescent equivalent) or 25W (50W HID equivalent).

Listings: cUL listed for wet location. DLC listed. LM-80 certified. IP65 rated.

Warranty: ELCO Lighting warrants products will be free from defects in materials and workmanship for a period of 5 years.

Product Number

Item	Lamp type	Lumens	CCT	Watts	Voltage	Finish
EWM25W30	LED	2600 lm	3000K	25W	120/277V	Dark Bronze

Product Number Builder Example: EWM17W30

Wall Mount

Wattage

Color Temp.

EWM

17W 17 Watt
25W 25 Watt

30 3000K
40 4000K

LED Wall Mount with Photocell

Multiplier: 3000K (x 0.96)

PHOTOMETRIC REPORT

Product #: EWM17W40
 Wattage/Lumens: 17.1W/ 1642 Lm
 Luminaire LPW: 96 Lm/W

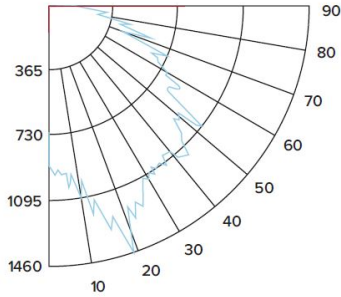

CANDLE POWER SUMMARY

Degrees Vertical	0°
0	691
5	879
15	813
25	624
35	554
45	514
55	322
65	90
75	15
85	8
90	5

ILLUMINANCE AT A DISTANCE

Distance to Target Plane	Footcandles Beam Center	Beam Diameter
4'	43.2	4.2'
6'	19.2	6.3'
8'	10.8	8.4'
10'	6.91	10.6'

ZONAL LUMEN SUMMARY

Zone	Lumens	% Luminaire
0-30°	439.51	26.80
0-40°	711.18	43.30
0-60°	1273.7	77.60
0-90°	1598.81	97.40

LED Wall Mount with Photocell

Multiplier: 4000K (x 1.04)

PHOTOMETRIC REPORT

Product #: EWM25W30
 Wattage/Lumens: 25.1W/ 2035 Lm
 Luminaire LPW: 81 Lm/W

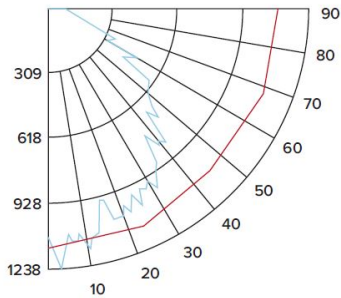

CANDLE POWER SUMMARY

Degrees Vertical	0°
0	1080
5	1048
15	907
25	735
35	758
45	645
55	453
65	252
75	50
85	11
90	9

ILLUMINANCE AT A DISTANCE

Distance to Target Plane	Footcandles Beam Center	Beam Diameter
4'	67.5	8.0'
6'	30.0	12.1'
8'	16.9	16.1'
10'	10.8	20.1'

ZONAL LUMEN SUMMARY

Zone	Lumens	% Luminaire
0-30°	714.43	35.10
0-40°	1105.54	54.30
0-60°	1758.7	86.40
0-90°	1989.38	97.70