

LED Trilene™ Track Fixture

All track fixtures have adjustable adapters to be used with 120V Single or Two Circuit Track



Features

- Diecast adjustable track fixture.
- Integrated driver.
- 180° vertical adjustment, 358° rotation.
- 50,000 hours life-span
- 38° Beam angle standard. Optional Lenses for Trilene™ (ET615D): EP726C (15°) or EP727C (24°) available.
- Use with ELCO 120V Single or Double Circuit Track.
- High efficacy COB LED.
- This track head comes standard as H Style. J (Juno) and L (Lightolier) styles are available: For J style please order PJTHI (W/B) with the track head.

For L style please order PLTHI (W/B) with the track head.

Note these must be factory installed.

Specifications

| | |
|--------------------|-----------------------------------|
| Wattage | 17W |
| Lumens | 1300 lm |
| Voltage | 120V |
| Color Temp. | 2700K, 3000K, 3500K, 4000K, 5000K |
| Beam Angle | 38° |
| CRI | 90+ |

Options



White



Black

Product Number

| Item | Lumens | CCT | Watts | Voltage | Beam Angle | Finish |
|------------|---------|-----------------------------------|-------|---------|------------|-----------|
| ET615CT5DW | 1300 lm | 2700K, 3000K, 3500K, 4000K, 5000K | 17W | 120V | 38° | All White |

Technical Details

Construction: Full diecast construction for exceptional heat management and lasting quality. Powder coat architectural white and architectural black matte finishes.

Adjustability: Track head is adjustable 180° vertically with 358° rotation.

Optics: Lens provides smooth lumen output at standard 38°. Lens available as accessory for ET615D with 15° (EP726C) or 24° (EP727C).

Installation: Effortlessly installed into H-Style track from ELCO or others. Compatible with Single and Double circuit track. Can be special ordered as J-Style (requires PJTLO W/B/) or L-Style (requires PLTLO W/B/).

LED Technology:

- Extremely accurate Color Rendering Index of 93+ CRI
- Efficacy of over 81 lumens per watt
- Lumen Maintenance of 50,000 hours L70 Life based on LM80 standardized test results
- Instant On to Full Brightness technology
- Chip on Board LED design results in a smooth lumen output with no LED pixelation

Dimmability:

- Triac and ELV dimmable down to 10%

- Flicker-Free Dimming
- For full list of dimmers refer to the Dimmer Compatibility List

Electrical:

- Driver is rated for 120V input
- High Efficiency driver with a power factor > 0.9

Listings:

- ETL Listed
- RoHS Compliant

Warranty: ELCO Products are built to last. 5-year Limited warranty.

Dimensions:

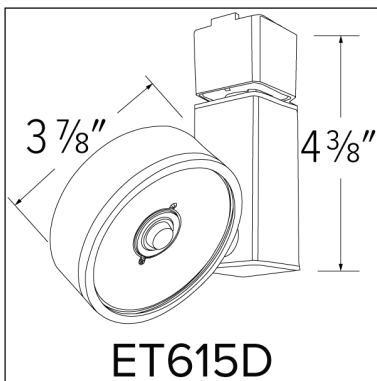

Product Number Builder Example: **ET615CT5DW**

| LED Trilene™ Track Fixture | Lumens | Color Temperature | Dimmable | Finish |
|----------------------------|--------------------|--|----------|--|
| ET | 615 1300 lm | CT3 3000K, 3500K, 4000K CT5 2700K - 5000K | D | W All White B All Black |

Single Circuit



Single Circuit Track

Track supplied with dead end and mounting hardware

| CAT NO. | SPECIFICATIONS |
|---------|----------------|
| EP002W | White / 2' |
| EP004W | White / 4' |
| EP006W | White / 6' |
| EP008W | White / 8' |
| EP012W | White / 12' |
| EP002B | Black / 2' |
| EP004B | Black / 4' |
| EP006B | Black / 6' |
| EP008B | Black / 8' |
| EP0012B | Black / 12' |
| EP002BZ | Bronze / 2' |
| EP004BZ | Bronze / 4' |
| EP006BZ | Bronze / 6' |
| EP008BZ | Bronze / 8' |
| EP002N | Nickel / 2' |
| EP004N | Nickel / 4' |
| EP006N | Nickel / 6' |
| EP008N | Nickel / 8' |



12' Track Kit

Includes: (2) Single Track (EP006) & (1) Mini Connector (EP808)

| CAT NO. | SPECIFICATIONS |
|---------|----------------|
| EP12XW | White |
| EP12XB | Black |
| EP12XBZ | Bronze |
| EP12XN | Nickel |

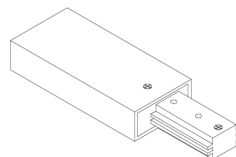

Live End Connector

Live end connector used for direct wiring

| CAT NO. | SPECIFICATIONS |
|---------|----------------|
| EP801W | White |
| EP801B | Black |
| EP801BZ | Bronze |
| EP801N | Nickel |

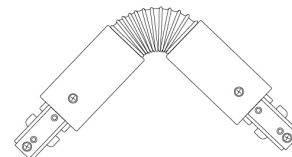

Flexible Connector

Flexible connector to join two track sections at an angle up to 90°. Can be used as a feed point

| CAT NO. | SPECIFICATIONS |
|---------|----------------|
| EP802W | White |
| EP802B | Black |
| EP802BZ | Bronze |
| EP802N | Nickel |



Straight Connector

Power feedable connector to join two track sections

| CAT NO. | SPECIFICATIONS |
|---------|----------------|
| EP803W | White |
| EP803B | Black |
| EP803BZ | Bronze |
| EP803N | Nickel |

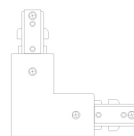

L Connector

Power feedable connector to join two track sections at a 90° angle

| CAT NO. | SPECIFICATIONS |
|---------|----------------|
| EP804W | White |
| EP804B | Black |
| EP804BZ | Bronze |
| EP804N | Nickel |

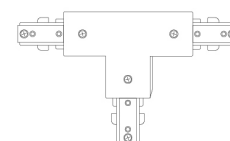

T Connector

Power feedable connector to join three track sections

| CAT NO. | SPECIFICATIONS |
|---------|----------------|
| EP805W | White |
| EP805B | Black |
| EP805BZ | Bronze |
| EP805N | Nickel |

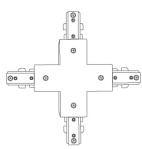

X Connector

Power feedable connector to join four track sections

| CAT NO. | SPECIFICATIONS |
|---------|----------------|
| EP806W | White |
| EP806B | Black |
| EP806BZ | Bronze |
| EP806N | Nickel |



Mini Connector

Mini Connector to join two track sections. Cannot be used as a feed point

| CAT NO. | SPECIFICATIONS |
|---------|----------------|
| EP808W | White |
| EP808B | Black |
| EP808BZ | Bronze |
| EP808N | Nickel |



Floating Canopy

Can be used anywhere along length of track to supply power. Includes end cap

| CAT NO. | SPECIFICATIONS |
|---------|----------------|
| EP809W | White |
| EP809B | Black |
| EP809BZ | Bronze |
| EP809N | Nickel |



End Feed Kit

Kit includes live end feed and canopy to mount on outlet box. 4 1/2" x 4 1/2" x 1/4" thick

| CAT NO. | SPECIFICATIONS |
|---------|----------------|
| EP810W | White |
| EP810B | Black |
| EP810BZ | Bronze |
| EP810N | Nickel |

Single Circuit



Dead End

Dead end cap for single and double circuit track

| CAT NO. | SPECIFICATIONS |
|---------|----------------|
| EP812W | White |
| EP812B | Black |
| EP812BZ | Bronze |
| EP812N | Nickel |



T-Bar Ceiling Feed

Live feed with outlet box for use with T-bar ceilings

| CAT NO. | SPECIFICATIONS |
|---------|----------------|
| EP817W | White |
| EP817B | Black |
| EP817BZ | Bronze |
| EP817N | Nickel |



Dead Mini Connector

Dead Mini Connector to join two track sections without passing the power

| CAT NO. | SPECIFICATIONS |
|---------|----------------|
| EP825W | White |
| EP825B | Black |
| EP825BZ | Bronze |
| EP825N | Nickel |



T-Bar Ceiling Feed

In-line T-bar ceiling feed

| CAT NO. | SPECIFICATIONS |
|---------|----------------|
| EP827W | White |
| EP827B | Black |



Cord and Plug Connector

Cord and Plug Connector for single circuit track. 10 Amp MAX or 1200W. 12 ft. long

| CAT NO. | SPECIFICATIONS |
|---------|----------------|
| EP850W | White |
| EP850B | Black |
| EP850BZ | Bronze |
| EP850N | Nickel |



Conduit Connector

To start a surface run

| CAT NO. | SPECIFICATIONS |
|---------|----------------|
| EP880W | White |
| EP880B | Black |
| EP880BZ | Bronze |
| EP880N | Nickel |



Live Feed with Current Limiter

Current Limiter for single circuit track. 1A to 12A available

| CAT NO. | SPECIFICATIONS |
|-------------|------------------|
| EP840W-1A | White \ 1 Amp |
| EP840W-2A | White \ 2.5 Amp |
| EP840W-5A | White \ 5 Amp |
| EP840W-7A | White \ 7.5 Amp |
| EP840W-10A | White \ 10 Amp |
| EP840W-12A | White \ 12 Amp |
| EP840B-1A | Black \ 1 Amp |
| EP840B-2A | Black \ 2.5 Amp |
| EP840B-5A | Black \ 5 Amp |
| EP840B-7A | Black \ 7.5 Amp |
| EP840B-10A | Black \ 10 Amp |
| EP840B-12A | Black \ 12 Amp |
| EP840BZ-1A | Bronze \ 1 Amp |
| EP840BZ-2A | Bronze \ 2.5 Amp |
| EP840BZ-5A | Bronze \ 5 Amp |
| EP840BZ-7A | Bronze \ 7.5 Amp |
| EP840BZ-10A | Bronze \ 10 Amp |
| EP840BZ-12A | Bronze \ 12 Amp |



In-Line Feed Connector with Current Limiter

Current Limiter for single circuit track. 1A to 12A available

| CAT NO. | SPECIFICATIONS |
|------------|-----------------|
| EP841W-1A | White \ 1 Amp |
| EP841W-2A | White \ 2.5 Amp |
| EP841W-5A | White \ 5 Amp |
| EP841W-7A | White \ 7.5 Amp |
| EP841W-10A | White \ 10 Amp |
| EP841W-12A | White \ 12 Amp |
| EP841B-1A | Black \ 1 Amp |
| EP841B-2A | Black \ 2.5 Amp |
| EP841B-5A | Black \ 5 Amp |
| EP841B-7A | Black \ 7.5 Amp |
| EP841B-10A | Black \ 10 Amp |
| EP841B-12A | Black \ 12 Amp |



Conduit Continuation Kit

Kit includes: (1) Left and (1) Right feed, to continue around obstructions with 1/2" surface conduit

| CAT NO. | SPECIFICATIONS |
|---------|----------------|
| EP979W | White |
| EP979B | Black |

Two Circuit



Two Circuit Track

Track supplied with dead end and mounting hardware

| CAT NO. | SPECIFICATIONS |
|---------|----------------|
| EC002W | White / 2' |
| EC004W | White / 4' |
| EC006W | White / 6' |
| EC008W | White / 8' |
| EC012W | White / 12' |
| EC002B | Black / 2' |
| EC004B | Black / 4' |
| EC006B | Black / 6' |
| EC008B | Black / 8' |
| EC012B | Black / 12' |



Live End Connector

Two circuit live end connector to start a run

| CAT NO. | SPECIFICATIONS |
|---------|----------------|
| EC801W | White |
| EC801B | Black |



Flexible Connector

Flexible connector to join two track sections at an angle up to 90°

| CAT NO. | SPECIFICATIONS |
|---------|----------------|
| EC802W | White |
| EC802B | Black |

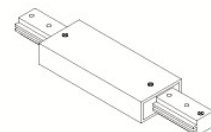

Straight Connector

Power feedable connector to join two track sections

| CAT NO. | SPECIFICATIONS |
|---------|----------------|
| EC803W | White |
| EC803B | Black |



L Connector

Power feedable connector to join two track sections at a 90° angle

| CAT NO. | SPECIFICATIONS |
|---------|----------------|
| EC804W | White |
| EC804B | Black |



T Connector

Power feedable connector to join three track sections

| CAT NO. | SPECIFICATIONS |
|---------|----------------|
| EC805W | White |
| EC805B | Black |

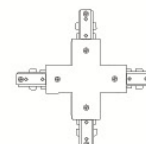

X Connector

Power feedable connector to join four track sections

| CAT NO. | SPECIFICATIONS |
|---------|----------------|
| EC806W | White |
| EC806B | Black |



Mini Connector

Mini Connector to join two track sections. Cannot be used as a feed point

| CAT NO. | SPECIFICATIONS |
|---------|----------------|
| EC808W | White |
| EC808B | Black |



Floating Canopy

Can be used anywhere along length of track to supply power. Includes end cap

| CAT NO. | SPECIFICATIONS |
|---------|----------------|
| EC809W | White |
| EC809B | Black |



Dead End

Dead end cap for single and double circuit track

| CAT NO. | SPECIFICATIONS |
|---------|----------------|
| EP812W | White |
| EP812B | Black |



T-Bar Ceiling Feed

Live feed with outlet box for use with T-bar ceilings

| CAT NO. | SPECIFICATIONS |
|---------|----------------|
| EC817W | White |
| EC817B | Black |



Conduit Connector

To start a surface run

| CAT NO. | SPECIFICATIONS |
|---------|----------------|
| EC880W | White |
| EC880B | Black |

Two Circuit



**Two Circuit Live-End Feed Connector
with Current Limiter**

1A to 12A available. Separate circuit breaker for each circuit.
Custom current rating available upon request

| CAT NO. | SPECIFICATIONS | CIRCUIT 1 | | CIRCUIT 2 | |
|---------|----------------|-----------|----------|-----------|----------|
| EC840W | White | 1A | 1 Amp | 1A | 1 Amp |
| EC840B | Black | 2A | 2.5 Amp | 2A | 2.5 Amp |
| | | 5A | 5 Amp | 5A | 5 Amp |
| | | 7A | 7.5 Amp | 7A | 7.5 Amp |
| | | 10A | 10 Amp | 10A | 10 Amp |
| | | 12A | 12.5 Amp | 12A | 12.5 Amp |



**Two Circuit In-Line Feed Connector
with Current Limiter**

1A to 12A available. Separate circuit breaker for each circuit.
Custom current rating available upon request

| CAT NO. | SPECIFICATIONS | CIRCUIT 1 | | CIRCUIT 2 | |
|---------|----------------|-----------|----------|-----------|----------|
| EC841W | White | 1A | 1 Amp | 1A | 1 Amp |
| EC841B | Black | 2A | 2.5 Amp | 2A | 2.5 Amp |
| | | 5A | 5 Amp | 5A | 5 Amp |
| | | 7A | 7.5 Amp | 7A | 7.5 Amp |
| | | 10A | 10 Amp | 10A | 10 Amp |
| | | 12A | 12.5 Amp | 12A | 12.5 Amp |

General

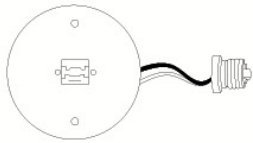

Track Adapter Trim

For use with standard 6" recessed housings. Allow track lamp holders to be used with recessed installations. Up to 150W Max. 7 1/2" O.D.

| CAT NO. | SPECIFICATIONS |
|---------|----------------|
| EP577W | White |
| EP577B | Black |

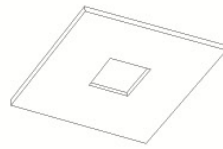

Outlet Box Cover

Outlet box cover. Screws not included. 5" x 5" x 1/8" x 1 1/4" Sq

| CAT NO. | SPECIFICATIONS |
|---------|----------------|
| EP800W | White |
| EP800B | Black |
| EP800BZ | Bronze |



Monopoint Canopy

Allows any lamp holder (300W MAX.) to be converted to canopy installation. For Line Voltage fixtures

| CAT NO. | SPECIFICATIONS |
|---------|----------------|
| EP811W | White |
| EP811B | Black |
| EP811BZ | Bronze |
| EP811N | Nickel |



Sign Hanger

Sign Hanger with hook for single and double circuit track. Holds up to 25 lbs

| CAT NO. | SPECIFICATIONS |
|---------|----------------|
| EP813W | White |
| EP813B | Black |
| EP813BZ | Bronze |
| EP813N | Nickel |



Outlet Adapter

Outlet Adapter for single circuit and two circuit track

| CAT NO. | SPECIFICATIONS |
|---------|----------------|
| EP814W | White |
| EP814B | Black |
| EP814BZ | Bronze |
| EP814N | Nickel |



Pendant Adapter

For single circuit and two circuit track with strain relief connector for cord or chain hung fixtures. Holds up to 35 lbs

| CAT NO. | SPECIFICATIONS |
|---------|----------------|
| EP815W | White |
| EP815B | Black |
| EP815BZ | Bronze |
| EP815N | Nickel |



Round Monopoint Canopy

For Line Voltage fixtures. 4 5/8" O.D.

| CAT NO. | SPECIFICATIONS |
|---------|----------------|
| EP819W | White |
| EP819B | Black |
| EP819BZ | Bronze |



Straight Channel

Provides support for straight connection points in suspended track system. Track sits inside the channel. 16 1/4" long. Support rails for tracks

| CAT NO. | SPECIFICATIONS |
|---------|----------------|
| EP844W | White |
| EP844B | Black |



L Channel

Support corner connection points in suspended track system. Track sits inside the channel. 16 1/4" long in each side. Support rails for tracks

| CAT NO. | SPECIFICATIONS |
|---------|----------------|
| EP845W | White |
| EP845B | Black |

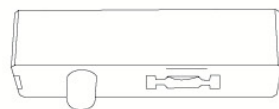

Dimmer Switch

Dimmer with ON/OFF switch. For Line Voltage fixtures. 150W MAX. For use with extension wands. Halogen lamps only

| CAT NO. | SPECIFICATIONS |
|---------|----------------|
| EP901W | White |
| EP901B | Black |



Clamp Cord and Plug

Clamp with 6 ft. cord and plug with female track connector for attaching a Line Voltage fixture

| CAT NO. | SPECIFICATIONS |
|---------|----------------|
| EP903W | White |
| EP903B | Black |



48" Steel Stem

For additional pendant length. Includes coupling. Use with EP918, EP924, EP936, and EP948

| CAT NO. | SPECIFICATIONS |
|---------|----------------|
| EP904W | White |
| EP904B | Black |

General



T-Bar Attachment Clip

Allows track to be attached to inverted T-Bar ceiling. Order as follow: (2) clips for 2' or 4' track, (3) clips for 6' track, (4) clips for 8' or 12' track

| CAT NO. | SPECIFICATIONS |
|---------|----------------|
| EP989B | Black |



Slope Ceiling Fixture Adapter

Allows use of extension wands on slope ceiling. 0°- 90°

| CAT NO. | SPECIFICATIONS |
|---------|----------------|
| EP906W | White |
| EP906B | Black |



Track Pendant Kit

Track pendant kit with 60" stainless steel cable. 1/16" stranded

| CAT NO. | SPECIFICATIONS |
|---------|----------------|
| EP960W | White |
| EP960B | Black |



Clamp Cord and Track Adapter

Connects to Line Voltage track. Includes female track connector for attaching a Line Voltage fixture

| CAT NO. | SPECIFICATIONS |
|---------|----------------|
| EP907W | White |
| EP907B | Black |



Pendant Assembly

Suspends track from ceiling. Order as follow: (2) kits for 2' or 4' track, (3) kits for 6' track, (4) kits for 8' track, (5) kits for 12', (1) EP807 per feed

| CAT NO. | SPECIFICATIONS |
|---------|----------------|
| EP918W | White \ 18" |
| EP924W | White \ 24" |
| EP936W | White \ 36" |
| EP948W | White \ 48" |
| EP918B | Black \ 18" |
| EP924B | Black \ 24" |
| EP936B | Black \ 36" |
| EP948B | Black \ 48" |



Sloped Ceiling Pendant Adapter

Sloped Ceiling Pendant adapter for use with EP918, EP924, EP936, and EP948

| CAT NO. | SPECIFICATIONS |
|---------|----------------|
| EP905W | White |
| EP905B | Black |



Wire Cover

Wire cover for power feed through with pendant assembly. One per run. For use with EP918 to EP948

| CAT NO. | SPECIFICATIONS |
|---------|----------------|
| EP807W | White |
| EP807B | Black |
| EP807BZ | Bronze |
| EP807N | Nickel |

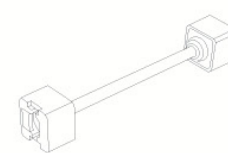

Extension Wand

Line voltage extension wands. Drops head from track

| CAT NO. | SPECIFICATIONS |
|---------|----------------|
| EP881W | 6" |
| EP882W | 12" |
| EP818W | 18" |
| EP824W | 24" |
| EP836W | 36" |
| EP848W | 48" |
| EP881B | 6" |
| EP882B | 12" |
| EP818B | 18" |
| EP824B | 24" |
| EP836B | 36" |
| EP848B | 48" |



ELCO Lighting

Dimmer Compatibility Chart

LED Track Fixtures

For ET612-ET621 Series

For Reference Only

Testing conducted by ELCO Lighting is not a substitute for and does not imply certification by an independent laboratory or any other standards certification. Refer to manufacturer specifications for more detailed information on product certifications and standards. Consult the dimmer manufacturer prior to installation to ensure compatibility.

| Manufacturer | Product | Part Number | Dimmed Light Output Range |
|-------------------------------|--|----------------|---------------------------|
| Triac/ELV Type Dimmers | | | |
| Lutron | Ariadni® 150W Single Pole/3-Way Dimmer | AYCL-153P | 10% - 100% |
| | Ariadni® 250W Single Pole/3-Way Dimmer | AYCL-253P | 10% - 100% |
| | Skylark Contour® 150W Single Pole/3-Way Dimmer | CTCL-153P | 10% - 100% |
| | Diva® 150W Single Pole/3-Way Dimmer | DVCL-153P | 10% - 100% |
| | Diva® 250W Single Pole/3-Way Dimmer | DVCL-253P | 10% - 100% |
| | Diva® 300W Single Pole/3-Way Dimmer Commercial/Residential Application | DVELV-300P | 10% - 100% |
| | Diva® 450W 3-Way Magnetic Low Voltage Dimmer | DVLV-603P | 10% - 100% |
| | Diva® 150W Single Pole/3-Way Dimmer | DVSCCL-153P | 10% - 100% |
| | Diva® 250W Single Pole/3-Way Dimmer | DVSCCL-253P | 10% - 100% |
| | Diva® 150W Single Pole/3-Way Dimmer | DVWCL-153PH-WH | 10% - 100% |
| | Grafik T® 150W Single Pole Dimmer | GT-150 | 10% - 100% |
| | Grafik T® 250W Single Pole/Multi-Location Dimmer | GTJ-250M | 10% - 100% |
| | Maestro® 150W Single Pole/3-Way/Multi-Location Dimmer | MACL-153MH-WH | 10% - 100% |
| | Skylark® 150W Single Pole/3-Way Dimmer | SCL-153P | 10% - 100% |
| | Skylark® 300W Single Pole Electronic Low Voltage Dimmer | SELV-300P | 10% - 100% |
| | Toggler® 150W Single Pole/3-Way Dimmer | TGCL-153P | 10% - 100% |

***NOTE: Refer to dimmer manufacturer’s documentation for installation instructions and circuit details**

Disclaimer: Minimum and maximum loads for LEDs and CFLs are given in number of lamps and may vary depending on the lamp being used. Testing conducted by ELCO Lighting is not a substitute for and does not imply certification by an independent laboratory or any other standards certification. Refer to manufacturer specifications for more detailed information on product certifications and standards.

Integrating our lighting with your Smart Home System is a breeze. Simply check your Smart Home system for compatible smart switches and cross reference that with our Dimming Compatibility Chart. Once the switches are integrated with your Smart Home system your lights will be ready to go.



2042 E. Vernon Ave. Vernon CA 90058 Tel 323.231.2600 Fax 323.231.3200 elcolighting.com