

LED Stein™ Track Fixture

All track fixtures have adjustable adapters to be used with 120V Single or Two Circuit Track.



Features

- Diecast adjustable track fixture.
- Integrated driver.
- 50,000 hours life-span.
- **ET616 & ET617 Series:** Includes 38° standard beam angle (installed), and field changeable 25° & 15° lenses in the box
- **ET843 Series:** Includes 38° standard beam angle (installed) and field changeable 60° lens in the box
- 180° vertical adjustment, 358° rotation.
- Use with ELCO 120V Single or Double Circuit Track.
- High efficacy COB LED.
- This track head comes standard as H Style. J (Juno) and L (Lightolier) styles are available: For J style please order PJTHI (W/B) with the track head.

For L style please order PLTHI (W/B) with the track head.

Note these must be factory installed.

- Optional: Snoot available. For use with Black finish track heads only.

Specifications

Wattage	24/30/36W
Lumens	2050/2600/3050 lm
Voltage	120V
Color Temp.	2700K, 3000K, 3500K, 4000K, 5000K
Lamp Type	LED
Beam Angle	38°

Options



White



Black



Optional Snoot



Louver

Technical Details

Construction: Full diecast construction for exceptional heat management and lasting quality. Powder coat architectural white and architectural black matte finishes.

Adjustability: Track head is adjustable 180° vertically with 358° rotation.

Optics: Lens provides smooth lumen output at standard 38° (installed), 25° and 15° lenses in the box (for ET616 & ET617 Series), and 60° lens in the box (for ET843 Series)

Installation: Effortlessly installed into H-Style track from ELCO or others. Compatible with Single and Double circuit track. Can be special ordered as J-Style (requires PJTLO W/B/) or L-Style (requires PLTLO W/B/).

LED Technology: Extremely accurate Color Rendering Index of 93+ CRI. Efficacy of over 83 lumens per watt. Lumen Maintenance of 50,000 hours L70 Life based on LM80 standardized test results. Instant On to Full Brightness technology. Chip on Board LED design results in a smooth lumen output with no LED pixelation

Dimmability: Triac and ELV dimmable down to 10%. For full list of dimmers refer to the Dimmer Compatibility List.

Electrical: Driver is rated for 120V input. High Efficiency driver with a power factor > 0.9

Listings: ETL Listed. RoHS Compliant.

ET616

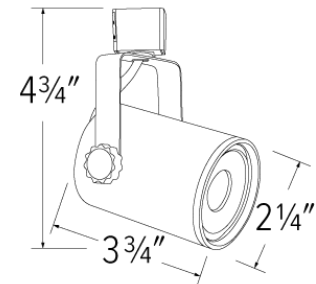

ET617

Warranty: ELCO Products are built to last. 5-year Limited warranty.

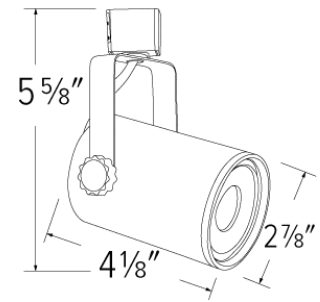

ET843

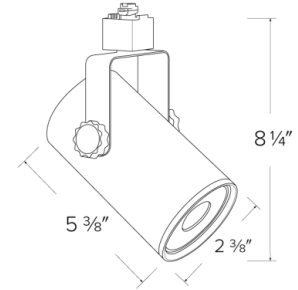

Product Number

Item	Description	Lamp type	Lumens	CCT	Watts	Voltage	Beam Angle	Finish
ET843CT5W	LED Stein™ Track Fixture with 5-CCT & 3-Wattage Switch	LED	2050/2600/3050 lm	2700K, 3000K, 3500K, 4000K, 5000K	24/30/36	120V	38°	All White

Product Number Builder Example: **ET616-27DW**

LED Stein™ Track Fixture

Lumens

Color Temp.

Dimmable

Finish

ET

616 800 lm

-27 2700K

D

W All White

- 617** 1500 lm
- 843** 2600 lm

- CT3** 3000K, 3500, 4000K
- CT5** 2700 - 5000K

- B** All Black

Single Circuit



Single Circuit Track

Track supplied with dead end and mounting hardware

CAT NO.	SPECIFICATIONS
EP002W	White / 2'
EP004W	White / 4'
EP006W	White / 6'
EP008W	White / 8'
EP012W	White / 12'
EP002B	Black / 2'
EP004B	Black / 4'
EP006B	Black / 6'
EP008B	Black / 8'
EP0012B	Black / 12'
EP002BZ	Bronze / 2'
EP004BZ	Bronze / 4'
EP006BZ	Bronze / 6'
EP008BZ	Bronze / 8'
EP002N	Nickel / 2'
EP004N	Nickel / 4'
EP006N	Nickel / 6'
EP008N	Nickel / 8'



12' Track Kit

Includes: (2) Single Track (EP006) & (1) Mini Connector (EP808)

CAT NO.	SPECIFICATIONS
EP12XW	White
EP12XB	Black
EP12XBZ	Bronze
EP12XN	Nickel



Live End Connector

Live end connector used for direct wiring

CAT NO.	SPECIFICATIONS
EP801W	White
EP801B	Black
EP801BZ	Bronze
EP801N	Nickel



Flexible Connector

Flexible connector to join two track sections at an angle up to 90°. Can be used as a feed point

CAT NO.	SPECIFICATIONS
EP802W	White
EP802B	Black
EP802BZ	Bronze
EP802N	Nickel



Straight Connector

Power feedable connector to join two track sections

CAT NO.	SPECIFICATIONS
EP803W	White
EP803B	Black
EP803BZ	Bronze
EP803N	Nickel

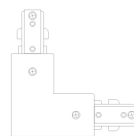

L Connector

Power feedable connector to join two track sections at a 90° angle

CAT NO.	SPECIFICATIONS
EP804W	White
EP804B	Black
EP804BZ	Bronze
EP804N	Nickel

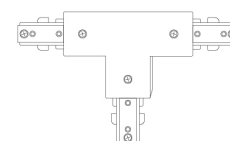

T Connector

Power feedable connector to join three track sections

CAT NO.	SPECIFICATIONS
EP805W	White
EP805B	Black
EP805BZ	Bronze
EP805N	Nickel



X Connector

Power feedable connector to join four track sections

CAT NO.	SPECIFICATIONS
EP806W	White
EP806B	Black
EP806BZ	Bronze
EP806N	Nickel



Mini Connector

Mini Connector to join two track sections. Cannot be used as a feed point

CAT NO.	SPECIFICATIONS
EP808W	White
EP808B	Black
EP808BZ	Bronze
EP808N	Nickel



Floating Canopy

Can be used anywhere along length of track to supply power. Includes end cap

CAT NO.	SPECIFICATIONS
EP809W	White
EP809B	Black
EP809BZ	Bronze
EP809N	Nickel



End Feed Kit

Kit includes live end feed and canopy to mount on outlet box. 4 1/2" x 4 1/2" x 1/4" thick

CAT NO.	SPECIFICATIONS
EP810W	White
EP810B	Black
EP810BZ	Bronze
EP810N	Nickel

Single Circuit



Dead End

Dead end cap for single and double circuit track

CAT NO.	SPECIFICATIONS
EP812W	White
EP812B	Black
EP812BZ	Bronze
EP812N	Nickel



T-Bar Ceiling Feed

Live feed with outlet box for use with T-bar ceilings

CAT NO.	SPECIFICATIONS
EP817W	White
EP817B	Black
EP817BZ	Bronze
EP817N	Nickel



Dead Mini Connector

Dead Mini Connector to join two track sections without passing the power

CAT NO.	SPECIFICATIONS
EP825W	White
EP825B	Black
EP825BZ	Bronze
EP825N	Nickel



T-Bar Ceiling Feed

In-line T-bar ceiling feed

CAT NO.	SPECIFICATIONS
EP827W	White
EP827B	Black



Cord and Plug Connector

Cord and Plug Connector for single circuit track. 10 Amp MAX or 1200W. 12 ft. long

CAT NO.	SPECIFICATIONS
EP850W	White
EP850B	Black
EP850BZ	Bronze
EP850N	Nickel



Conduit Connector

To start a surface run

CAT NO.	SPECIFICATIONS
EP880W	White
EP880B	Black
EP880BZ	Bronze
EP880N	Nickel



Live Feed with Current Limiter

Current Limiter for single circuit track. 1A to 12A available

CAT NO.	SPECIFICATIONS
EP840W-1A	White \ 1 Amp
EP840W-2A	White \ 2.5 Amp
EP840W-5A	White \ 5 Amp
EP840W-7A	White \ 7.5 Amp
EP840W-10A	White \ 10 Amp
EP840W-12A	White \ 12 Amp
EP840B-1A	Black \ 1 Amp
EP840B-2A	Black \ 2.5 Amp
EP840B-5A	Black \ 5 Amp
EP840B-7A	Black \ 7.5 Amp
EP840B-10A	Black \ 10 Amp
EP840B-12A	Black \ 12 Amp
EP840BZ-1A	Bronze \ 1 Amp
EP840BZ-2A	Bronze \ 2.5 Amp
EP840BZ-5A	Bronze \ 5 Amp
EP840BZ-7A	Bronze \ 7.5 Amp
EP840BZ-10A	Bronze \ 10 Amp
EP840BZ-12A	Bronze \ 12 Amp



In-Line Feed Connector with Current Limiter

Current Limiter for single circuit track. 1A to 12A available

CAT NO.	SPECIFICATIONS
EP841W-1A	White \ 1 Amp
EP841W-2A	White \ 2.5 Amp
EP841W-5A	White \ 5 Amp
EP841W-7A	White \ 7.5 Amp
EP841W-10A	White \ 10 Amp
EP841W-12A	White \ 12 Amp
EP841B-1A	Black \ 1 Amp
EP841B-2A	Black \ 2.5 Amp
EP841B-5A	Black \ 5 Amp
EP841B-7A	Black \ 7.5 Amp
EP841B-10A	Black \ 10 Amp
EP841B-12A	Black \ 12 Amp



Conduit Continuation Kit

Kit includes: (1) Left and (1) Right feed, to continue around obstructions with 1/2" surface conduit

CAT NO.	SPECIFICATIONS
EP979W	White
EP979B	Black

Two Circuit



Two Circuit Track

Track supplied with dead end and mounting hardware

CAT NO.	SPECIFICATIONS
EC002W	White / 2'
EC004W	White / 4'
EC006W	White / 6'
EC008W	White / 8'
EC012W	White / 12'
EC002B	Black / 2'
EC004B	Black / 4'
EC006B	Black / 6'
EC008B	Black / 8'
EC012B	Black / 12'



Live End Connector

Two circuit live end connector to start a run

CAT NO.	SPECIFICATIONS
EC801W	White
EC801B	Black



Flexible Connector

Flexible connector to join two track sections at an angle up to 90°

CAT NO.	SPECIFICATIONS
EC802W	White
EC802B	Black

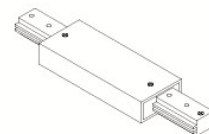

Straight Connector

Power feedable connector to join two track sections

CAT NO.	SPECIFICATIONS
EC803W	White
EC803B	Black



L Connector

Power feedable connector to join two track sections at a 90° angle

CAT NO.	SPECIFICATIONS
EC804W	White
EC804B	Black



T Connector

Power feedable connector to join three track sections

CAT NO.	SPECIFICATIONS
EC805W	White
EC805B	Black

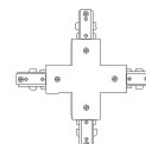

X Connector

Power feedable connector to join four track sections

CAT NO.	SPECIFICATIONS
EC806W	White
EC806B	Black



Mini Connector

Mini Connector to join two track sections. Cannot be used as a feed point

CAT NO.	SPECIFICATIONS
EC808W	White
EC808B	Black



Floating Canopy

Can be used anywhere along length of track to supply power. Includes end cap

CAT NO.	SPECIFICATIONS
EC809W	White
EC809B	Black



Dead End

Dead end cap for single and double circuit track

CAT NO.	SPECIFICATIONS
EP812W	White
EP812B	Black



T-Bar Ceiling Feed

Live feed with outlet box for use with T-bar ceilings

CAT NO.	SPECIFICATIONS
EC817W	White
EC817B	Black



Conduit Connector

To start a surface run

CAT NO.	SPECIFICATIONS
EC880W	White
EC880B	Black

Two Circuit



**Two Circuit Live-End Feed Connector
with Current Limiter**

1A to 12A available. Separate circuit breaker for each circuit.
Custom current rating available upon request

CAT NO.	SPECIFICATIONS	CIRCUIT 1		CIRCUIT 2	
EC840W	White	1A	1 Amp	1A	1 Amp
EC840B	Black	2A	2.5 Amp	2A	2.5 Amp
		5A	5 Amp	5A	5 Amp
		7A	7.5 Amp	7A	7.5 Amp
		10A	10 Amp	10A	10 Amp
		12A	12.5 Amp	12A	12.5 Amp



**Two Circuit In-Line Feed Connector
with Current Limiter**

1A to 12A available. Separate circuit breaker for each circuit.
Custom current rating available upon request

CAT NO.	SPECIFICATIONS	CIRCUIT 1		CIRCUIT 2	
EC841W	White	1A	1 Amp	1A	1 Amp
EC841B	Black	2A	2.5 Amp	2A	2.5 Amp
		5A	5 Amp	5A	5 Amp
		7A	7.5 Amp	7A	7.5 Amp
		10A	10 Amp	10A	10 Amp
		12A	12.5 Amp	12A	12.5 Amp

General

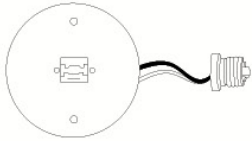

Track Adapter Trim

For use with standard 6" recessed housings. Allow track lamp holders to be used with recessed installations. Up to 150W Max. 7 1/2" O.D.

CAT NO.	SPECIFICATIONS
EP577W	White
EP577B	Black

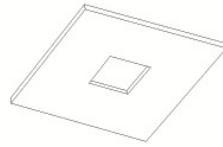

Outlet Box Cover

Outlet box cover. Screws not included. 5" x 5" x 1/8" x 1 1/4" Sq

CAT NO.	SPECIFICATIONS
EP800W	White
EP800B	Black
EP800BZ	Bronze

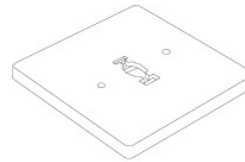

Monopoint Canopy

Allows any lamp holder (300W MAX.) to be converted to canopy installation. For Line Voltage fixtures

CAT NO.	SPECIFICATIONS
EP811W	White
EP811B	Black
EP811BZ	Bronze
EP811N	Nickel



Sign Hanger

Sign Hanger with hook for single and double circuit track. Holds up to 25 lbs

CAT NO.	SPECIFICATIONS
EP813W	White
EP813B	Black
EP813BZ	Bronze
EP813N	Nickel

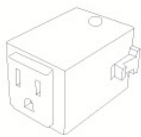

Outlet Adapter

Outlet Adapter for single circuit and two circuit track

CAT NO.	SPECIFICATIONS
EP814W	White
EP814B	Black
EP814BZ	Bronze
EP814N	Nickel



Pendant Adapter

For single circuit and two circuit track with strain relief connector for cord or chain hung fixtures. Holds up to 35 lbs

CAT NO.	SPECIFICATIONS
EP815W	White
EP815B	Black
EP815BZ	Bronze
EP815N	Nickel



Round Monopoint Canopy

For Line Voltage fixtures. 4 5/8" O.D.

CAT NO.	SPECIFICATIONS
EP819W	White
EP819B	Black
EP819BZ	Bronze

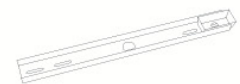

Straight Channel

Provides support for straight connection points in suspended track system. Track sits inside the channel. 16 1/4" long. Support rails for tracks

CAT NO.	SPECIFICATIONS
EP844W	White
EP844B	Black



L Channel

Support corner connection points in suspended track system. Track sits inside the channel. 16 1/4" long in each side. Support rails for tracks

CAT NO.	SPECIFICATIONS
EP845W	White
EP845B	Black

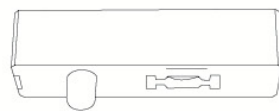

Dimmer Switch

Dimmer with ON/OFF switch. For Line Voltage fixtures. 150W MAX. For use with extension wands. Halogen lamps only

CAT NO.	SPECIFICATIONS
EP901W	White
EP901B	Black

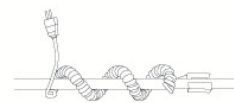

Clamp Cord and Plug

Clamp with 6 ft. cord and plug with female track connector for attaching a Line Voltage fixture

CAT NO.	SPECIFICATIONS
EP903W	White
EP903B	Black



48" Steel Stem

For additional pendant length. Includes coupling. Use with EP918, EP924, EP936, and EP948

CAT NO.	SPECIFICATIONS
EP904W	White
EP904B	Black

General



T-Bar Attachment Clip

Allows track to be attached to inverted T-Bar ceiling. Order as follow: (2) clips for 2' or 4' track, (3) clips for 6' track, (4) clips for 8' or 12' track

CAT NO.	SPECIFICATIONS
EP989B	Black



Slope Ceiling Fixture Adapter

Allows use of extension wands on slope ceiling. 0°- 90°

CAT NO.	SPECIFICATIONS
EP906W	White
EP906B	Black



Track Pendant Kit

Track pendant kit with 60" stainless steel cable. 1/16" stranded

CAT NO.	SPECIFICATIONS
EP960W	White
EP960B	Black



Clamp Cord and Track Adapter

Connects to Line Voltage track. Includes female track connector for attaching a Line Voltage fixture

CAT NO.	SPECIFICATIONS
EP907W	White
EP907B	Black



Pendant Assembly

Suspends track from ceiling. Order as follow: (2) kits for 2' or 4' track, (3) kits for 6' track, (4) kits for 8' track, (5) kits for 12', (1) EP807 per feed

CAT NO.	SPECIFICATIONS
EP918W	White \ 18"
EP924W	White \ 24"
EP936W	White \ 36"
EP948W	White \ 48"
EP918B	Black \ 18"
EP924B	Black \ 24"
EP936B	Black \ 36"
EP948B	Black \ 48"



Sloped Ceiling Pendant Adapter

Sloped Ceiling Pendant adapter for use with EP918, EP924, EP936, and EP948

CAT NO.	SPECIFICATIONS
EP905W	White
EP905B	Black

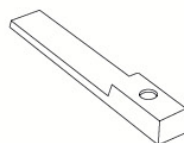

Wire Cover

Wire cover for power feed through with pendant assembly. One per run. For use with EP918 to EP948

CAT NO.	SPECIFICATIONS
EP807W	White
EP807B	Black
EP807BZ	Bronze
EP807N	Nickel

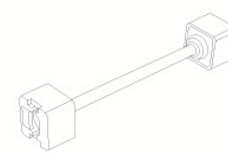

Extension Wand

Line voltage extension wands. Drops head from track

CAT NO.	SPECIFICATIONS
EP881W	6"
EP882W	12"
EP818W	18"
EP824W	24"
EP836W	36"
EP848W	48"
EP881B	6"
EP882B	12"
EP818B	18"
EP824B	24"
EP836B	36"
EP848B	48"



ELCO Lighting

Dimmer Compatibility Chart

LED Track Fixtures

For ET612-ET621 Series

For Reference Only

Testing conducted by ELCO Lighting is not a substitute for and does not imply certification by an independent laboratory or any other standards certification. Refer to manufacturer specifications for more detailed information on product certifications and standards. Consult the dimmer manufacturer prior to installation to ensure compatibility.

Manufacturer	Product	Part Number	Dimmed Light Output Range
Triac/ELV Type Dimmers			
Lutron	Ariadni® 150W Single Pole/3-Way Dimmer	AYCL-153P	10% - 100%
	Ariadni® 250W Single Pole/3-Way Dimmer	AYCL-253P	10% - 100%
	Skylark Contour® 150W Single Pole/3-Way Dimmer	CTCL-153P	10% - 100%
	Diva® 150W Single Pole/3-Way Dimmer	DVCL-153P	10% - 100%
	Diva® 250W Single Pole/3-Way Dimmer	DVCL-253P	10% - 100%
	Diva® 300W Single Pole/3-Way Dimmer Commercial/Residential Application	DVELV-300P	10% - 100%
	Diva® 450W 3-Way Magnetic Low Voltage Dimmer	DVLV-603P	10% - 100%
	Diva® 150W Single Pole/3-Way Dimmer	DVSCCL-153P	10% - 100%
	Diva® 250W Single Pole/3-Way Dimmer	DVSCCL-253P	10% - 100%
	Diva® 150W Single Pole/3-Way Dimmer	DVWCL-153PH-WH	10% - 100%
	Grafik T® 150W Single Pole Dimmer	GT-150	10% - 100%
	Grafik T® 250W Single Pole/Multi-Location Dimmer	GTJ-250M	10% - 100%
	Maestro® 150W Single Pole/3-Way/Multi-Location Dimmer	MACL-153MH-WH	10% - 100%
	Skylark® 150W Single Pole/3-Way Dimmer	SCL-153P	10% - 100%
	Skylark® 300W Single Pole Electronic Low Voltage Dimmer	SELV-300P	10% - 100%
	Toggler® 150W Single Pole/3-Way Dimmer	TGCL-153P	10% - 100%

***NOTE: Refer to dimmer manufacturer’s documentation for installation instructions and circuit details**

Disclaimer: Minimum and maximum loads for LEDs and CFLs are given in number of lamps and may vary depending on the lamp being used. Testing conducted by ELCO Lighting is not a substitute for and does not imply certification by an independent laboratory or any other standards certification. Refer to manufacturer specifications for more detailed information on product certifications and standards.

Integrating our lighting with your Smart Home System is a breeze. Simply check your Smart Home system for compatible smart switches and cross reference that with our Dimming Compatibility Chart. Once the switches are integrated with your Smart Home system your lights will be ready to go.



2042 E. Vernon Ave. Vernon CA 90058 Tel 323.231.2600 Fax 323.231.3200 elcolighting.com