

# Koto™ Architectural LED Light Engine

Works with 2", 3", 4" & 6" Koto™ Architectural Recessed Housings and Koto™ Trims



## Features

- Light engine used with Koto™ Architectural Housings
- See Koto™ Architectural housings for lumen output options. Final lumen output is determined by housing.
- Driver on housing extends lifespan and allows for more dimming and EM options
- Standard 38° Lens installed, 25° and 60° lens included with each module - Optional Lens: 18° (EP731C), 90° (EP739C)
- Optional: Louver (L45), Linear Lens (L46), Spread Lens (L47), Clear Lens (L48), Frosted Lens (L49), White Koto Snoot (L50W), Black Koto Snoot (L50B), Color Shifter (L51), Blue Lens (L52), Pink Lens (L53), Single Asymmetric Lens (L54), Double Asymmetric Lens (L55)
- Works in 2", 3", 4" & 6" ELCO Housings with Koto™ twist-on trims
- Excellent color rendering 95+ CRI
- Sunset option dims from 3000K to 1800K
- ENERGY STAR Certified
- Title 24 JA8-2019 Compliant
- Life span of 50,000 hours L70
- Covered by U.S. PATENTS and Patents Pending

## Specifications

<b>Wattage</b>	14.7 MAX.W - 18.9 MAX.W
<b>Lumens</b>	940 lm - 1950 lm
<b>Color Temp.</b>	2700K - SunsetK
<b>Lamp Type</b>	LED
<b>Beam Angle</b>	38° - 90°
<b>CRI</b>	95
<b>Wet Location</b>	cUL Listed w/Wet Location Trim
<b>Damp Location</b>	cUL Listed

## Dimensions

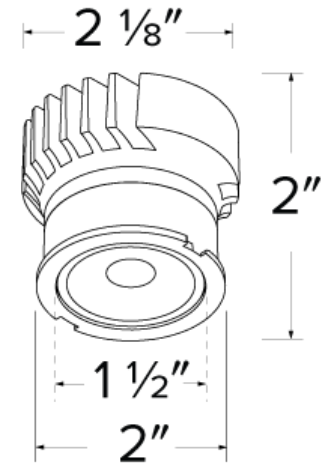

## Technical Details

**Optics:** PC lens diffuses light evenly throughout while reducing glare with LED COB technology.

**Construction:** Diecast aluminum body with heat fins allow for efficient cooling.

**Compatible Housings:** Koto™ Module is compatible with Architectural Housings:

- 120V/277V 0-10V/Triac/ELV (3 in 1 dimming: Triac, ELV and 0-10V dimming in one driver to 1%)
- 120V Triac/ELV with optional Emergency Battery Backup.

• E2LK57RICAD, E3LK65ICA, E3LK66ICAD, E3LK65RICA, E3LK66RICAD, E4LK87ICA, E4LK88ICAD, E4LK87RICA, E4LK88RICAD, ELK72FICA, ELK73FICAD (10W, 250mA) **ELK19 Delivered Lumens:** 2700K: 750 lm, 3000K: 770 lm, 3500K: 790 lm, 4000K: 810 lm, Sunset: 750 lm **ELK21 Delivered Lumens:** 2700K: 890 lm, 3000K: 930 lm, 3500K: 990 lm, 4000K: 1020 lm **ELK24 Delivered Lumens:** 2700K: 1016 lm, 3000K: 1060 lm, 3500K: 1100 lm, 4000K: 1150 lm

• E2LK34ICA, E2LK35ICAD, E3LK76ICA, E3LK77ICAD, E4LK98ICA, E4LK99ICAD (15W, 350mA) **ELK19 Delivered Lumens:** 2700K: 970 lm, 3000K: 1000 lm, 3500K: 1030 lm, 4000K: 1050 lm, Sunset: 940 lm **ELK21 Delivered Lumens:** 2700K:1140 lm, 3000K:1200 lm, 3500K: 1270 lm, 4000K: 1390 lm **ELK24 Delivered Lumens:** 2700K: 1390 lm, 3000K: 1450 lm, 3500K: 1510 lm, 4000K: 1570 lm

• E2LK41ICA, E2LK42ICAD, E3LK53ICA, E3LK54ICAD, E4LK47ICA, E4LK48ICAD (17W, 400mA) **ELK21 Delivered Lumens:** 2700K:1220 lm, 3000K:1290 lm, 3500K: 1360 lm, 4000K: 1400 lm **ELK24 Delivered Lumens:** 2700K: 1550 lm, 3000K: 1620 lm, 3500K: 1685 lm, 4000K: 1750 lm

## Product Numbers

Item	Lamp type	Lumens	CCT	Watts	Beam Angle
<b>ELK1927D</b>	LED	970 MAX. lm	2700K	14.7 MAX.	38°
<b>ELK2127D</b>	LED	1360 MAX. lm	2700K	18.9 MAX.	38°
<b>ELK2427D</b>	LED	1720 MAX. lm	2700KK	18.9 MAX.	38°
<b>ELK1930D</b>	LED	1000 MAX. lm	3000K	14.7 MAX.	38°
<b>ELK2130D</b>	LED	1430 MAX. lm	3000K	18.9 MAX.	38°
<b>ELK2430D</b>	LED	1800 MAX. lm	3000K	18.9 MAX.	38°
<b>ELK1935D</b>	LED	1030 MAX. lm	3500K	14.7 MAX.	38°
<b>ELK2135D</b>	LED	1510 MAX. lm	3500K	18.9 MAX.	38°

• E2LK94ICA, E2LK95ICAD, E3LK84ICA, E3LK85ICAD, E4LK78ICA, E4LK79ICAD, E6LK56ICA, E6LK57ICAD (19W, 450mA)  
**ELK21 Delivered Lumens:** 2700K:1360 lm, 3000K:1430 lm, 3500K: 1510 lm, 4000K: 1690 lm  
**ELK24 Delivered Lumens:** 2700K: 1720 lm, 3000K: 1800 lm, 3500K: 1875 lm, 4000K: 1950 lm

Compatible Architectural Housings - LUMEN OUTPUT per module					
Architectural Koto™ LED Module	Standard Housings (10W)	Shallow Housings (15W)	High Lumen Housings (17W)	High Lumen Housings (19W)	2-Hr Fire Rated Housings
	E2LK5 Series, E3LK6 Series, E4LK8 Series, E6LK37 Series*	E2LK3 Series, E3LK7 Series, E4LK9 Series	E2LK4 Series, E3LK5 Series, E4LK4 Series	E2LK9 Series, E3LK8 Series, E4LK7 Series, E6LK5 Series	ELK7 Series, ELK9 Series
<b>ELK19 Series</b>	~750 lm	~1000 lm	Not Compatible	Not Compatible	~750 lm
<b>ELK21 Series</b>	~950 lm	~1200 lm	~1450 lm	~1650 lm	~950 lm
<b>ELK24 Series</b>	~1100 lm	~1400 lm	~1750 lm	~1950 lm	~1100 lm

\* For ELK21 & ELK24 Series Only

**Installation:** Twist-on design for toolless trim installation, for use with Koto™ trims only. Can be use in 2", 3" & 4" Architectural Koto™ Housings only.

**LED Technology:** Extremely accurate Color Rendering Index (CRI) of 95+. Lumen Maintaine of 50,000 hours L70 Life based on LM80 standardized test results. Superior Thermal Management by utilizing integrated heat sink. Instant On to Full Brightness. No LED pixilation.

**Sunset:** Sunset color temperature is our dim-to-warm LED technology that allows the color temperature to become warmer as the product is dimmed. Our SUNSET items start at 3000K and go as low as 1800K when dimmed. For Sunset dim technology be sure to order an item with "Sunset" in the Color Temperature (CCT) attribute.

**Dimmability:** Based on housing used. See Koto™ Architectural Housings for options.

**Listings:** cUL Listed for Damp Locations. cUL Listed for Wet Location with Wet location trims. RoHS Compliant. ENERGY STAR® Certified. California Title 24 JA8-2019.

**Warranty:** ELCO Products are built to last with a 5-year Limited Warranty.

Item	Lamp type	Lumens	CCT	Watts	Beam Angle
<b>ELK2435D</b>	LED	1875 MAX. lm	3500KK	18.9 MAX.	38°
<b>ELK1940D</b>	LED	1050 MAX. lm	4000K	14.7 MAX.	38°
<b>ELK2140D</b>	LED	1690 MAX. lm	4000K	18.9 MAX.	38°
<b>ELK2440D</b>	LED	1950 MAX. lm	4000K	18.9 MAX.	38°
<b>ELK19SD</b>	LED	940 MAX. lm	SunsetK	14.7 MAX.	38°
<b>ELK1927D-E</b>	LED	970 MAX. lm	2700K	14.7 MAX.	90°
<b>ELK2127D-E</b>	LED	1360 MAX. lm	2700K	18.9 MAX.	90°
<b>ELK2427D-E</b>	LED	1720 MAX. lm	2700KK	18.9 MAX.	90°
<b>ELK1930D-E</b>	LED	1000 MAX. lm	3000K	14.7 MAX.	90°
<b>ELK2130D-E</b>	LED	1430 MAX. lm	3000K	18.9 MAX.	90°
<b>ELK2430D-E</b>	LED	1800 MAX. lm	3000K	18.9 MAX.	90°
<b>ELK1935D-E</b>	LED	1030 MAX. lm	3500K	14.7 MAX.	90°
<b>ELK2135D-E</b>	LED	1510 MAX. lm	3500K	18.9 MAX.	90°
<b>ELK2435D-E</b>	LED	1875 MAX. lm	3500KK	18.9 MAX.	90°
<b>ELK1940D-E</b>	LED	1050 MAX. lm	4000K	14.7 MAX.	90°
<b>ELK2140D-E</b>	LED	1690 MAX. lm	4000K	18.9 MAX.	90°
<b>ELK2440D-E</b>	LED	1950 MAX. lm	4000K	18.9 MAX.	90°
<b>ELK19SD-E</b>	LED	940 MAX. lm	SunsetK	14.7 MAX.	90°

## Product Number Builder Example: **ELK1927D**

Koto™ Architectural LED Module

Lumens (Wattage)

Color Temp.

Beam Angle

**ELK**

**19** Up to 1050 lm (14.7W MAX)<sup>1</sup>

**27D** 2700K

**38°**<sup>4</sup>

**21** Up to 1690 lm (18.9W MAX)<sup>1</sup>

**30D** 3000K

**-S** 18°

**24** Up to 1950 lm (18.9W MAX)<sup>1</sup>

**35D** 3500K

**-N** 25°

**40D** 4000K

**-W** 60°

**SD** Sunset (ELK19 Only)<sup>2,3</sup>

**-E** 90°<sup>5</sup>

<sup>1</sup> Lumen output varies based on the architectural Koto housing used

<sup>2</sup> Available with ELK19 module only

<sup>3</sup> Sunset, Dim to Warm technology, automatically transitions from 3000K to 1800K when dimmed

<sup>4</sup> 38° lens installed. Includes 25° and 60° lens with module.

<sup>5</sup> 90° Frosted Reflector

# Compatible Products



For use with Koto™ Architectural LED Light Engine

## 2" Koto™ Architectural Recessed Housings

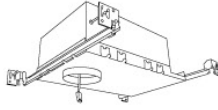

2" Shallow Maximum Adjustability ICA Housing  
 1000 lm (14.7W) w/ELK19 Series Module  
 1200 lm (14.7W) w/ELK21 Series Module  
 1500 lm (14.7W) w/ELK24 Series Module  
**Shallow New Construction**

CAT NO.	SPECIFICATIONS
E2LK34ICA	120V - Triac/ELV
E2LK35ICAD	120/277V - 0-10V/Triac/ELV <sup>1</sup>

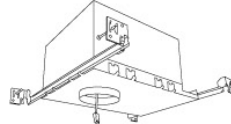

2" Maximum Adjustability ICA Housing  
 1350 lm (15.7W) w/ELK21 Series Module  
 1650 lm (15.7W) w/ELK24 Series Module  
**New Construction**

CAT NO.	SPECIFICATIONS
E2LK41ICA	120V - Triac/ELV
E2LK42ICAD	120/27V - 0-10V/Triac/ELV <sup>1</sup>

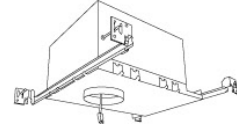

2" Maximum Adjustability ICA Housing  
 1500 lm (18.9W) w/ELK21 Series Module  
 1850 lm (18.9W) w/ELK24 Series Module  
**High Lumen New Construction**

CAT NO.	SPECIFICATIONS
E2LK94ICA	120V - Triac/ELV
E2LK95ICAD	120/27V - 0-10V/Triac/ELV <sup>1</sup>

<sup>1</sup> 3 in 1 dimming: Triac, ELV and 0-10V dimming in one driver to 1%

## 2" Pex™ Twist-On Trims



**Round Deep Reflector**  
**ELK2818**  
 Finishes:  
 (W, B, H, BB, BZ)



**Round Adjustable Reflector**  
**ELK2829**  
 Finishes:  
 (W, B, H, BB, BZ)



**Round Adjustable Pinhole**  
**ELK2827**  
 Finishes:  
 (W, B, BB, BZ)



**Round Curved Reflector**  
**ELK2872**  
 Finishes:  
 (W, B\*)

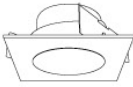

**Square Deep Reflector**  
**ELK2518**  
 Finishes:  
 (W, B, BB)

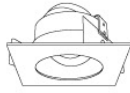

**Square Adjustable Reflector**  
**ELK2529**  
 Finishes:  
 (W, B, BB)

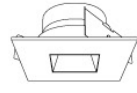

**Square Reflector**  
**ELK2541**  
 Finishes:  
 (W, B, BB)

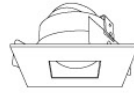

**Square Adjustable Pinhole**  
**ELK2527**  
 Finishes:  
 (W, B, BB)



**Round Gimbal**  
**ELK2888**  
 Finishes:  
 (W, B\*, BZ)

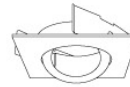

**Square Gimbal**  
**ELK2588**  
 Finishes:  
 (W, B\*, BZ)



**Round Adj. Trimless Reflector**  
**ELK215**  
 Finishes:  
 (W, B\*)



**Trimless Spackle Frame**  
**EL2SFR**  
 For use with ELK215

Finishes: **W** - All White, **BB** - All Black, **BZ** - All Bronze, **B** - Black w/White Ring, **C** - Chrome w/White Ring, **H** - Haze w/White Ring, **B\*** - All Black (For ELK2872, ELK2888, ELK2588, & ELK215)

# Compatible Products



For use with **Koto™** Architectural LED Light Engine

## 3" Koto™ Architectural Recessed Housings

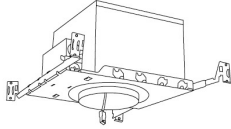

3" High Lumen Maximum Adjustability ICA Housing  
1500 lm (18.9W) w/ELK21 Series Module  
1650-1850 lm (18.9W) w/ELK24 Series Module  
**New Construction**

CAT NO.	SPECIFICATIONS
E3LK53ICA	120V - Triac/ELV
E3LK54ICAD	120/277V - 0-10V/Triac/ELV <sup>1</sup>
E3LK84ICA	120V - Triac/ELV
E3LK85ICAD	120/277V - 0-10V/Triac/ELV <sup>1</sup>

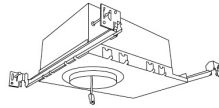

3" Shallow Maximum Adjustability ICA Housing  
850 lm (14.7W) w/ELK19 Series Module  
1100 lm (14.7W) w/ELK21 Series Module  
1500 lm (14.7W) w/ELK24 Series Module  
**New Construction**

CAT NO.	SPECIFICATIONS
E3LK76ICA	120V - Triac/ELV
E3LK77ICAD	120/277V - 0-10V/Triac/ELV <sup>1</sup>



3" Standard ICA Housing  
750 lm (10.5W) w/ELK19 Series Module  
950 lm (10.5W) w/ELK21 Series Module  
1350 lm (10.5W) w/ELK24 Series Module  
**New Construction**

CAT NO.	SPECIFICATIONS
E3LK65ICA	120V - Triac/ELV
E3LK65ICA-EM1	Emergency Battery Back-Up
E3LK66ICAD	120/277V - 0-10V/Triac/ELV <sup>1</sup>
E3LK66ICAD-EM1	Emergency Battery Back-Up



3" Standard ICA Housing  
750 lm (10.5W) w/ELK19 Series Module  
950 lm (10.5W) w/ELK21 Series Module  
1350 lm (10.5W) w/ELK24 Series Module  
**Remodel**

CAT NO.	SPECIFICATIONS
E3LK65RICA	120V - Triac/ELV
E3LK66RICAD	120/277V - 0-10V/Triac/ELV <sup>1</sup>



2-Hour Fire Rated 3" ICA Housing  
750 lm (10.5W) w/ELK19 Series Module  
950 lm (10.5W) w/ELK21 Series Module  
1350 lm (10.5W) w/ELK24 Series Module  
**New Construction**

CAT NO.	SPECIFICATIONS
ELK72FICA	120V - Triac/ELV
ELK73FICAD	120/277V - 0-10V/Triac/ELV <sup>1</sup>

<sup>1</sup>3 in 1 dimming: Triac, ELV and 0-10V dimming in one driver to 1%

## 3" Pex™ Twist-On Trims



**Round Deep Reflector**  
**ELK3618**  
Finishes:  
(W, BB, BZ, B, C, H)

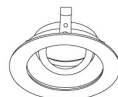

**Round Adjustable Gimbal**  
**ELK3629**  
Finishes:  
(W, BB, BZ, B, C, H)



**Round Adjustable Pinhole**  
**ELK3627**  
Finishes:  
(B, BB, BZ, B, H)



**Round Adj. Slot Aperture**  
**ELK3620**  
Finishes:  
(W)



**Round Adj. Wall Wash**  
**ELK3622**  
Finishes:  
(W)

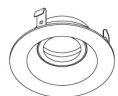

**Round Regressed Eyeball**  
**ELK3653**  
Finishes:  
(W, BB, B)



**Round Curved Reflector**  
**ELK3672**  
Finishes:  
(W, B)

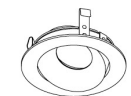

**Round Directional Gimbal**  
**ELK3679**  
Finishes:  
(W, BB, B, H)

Finishes: **W** - All White, **BB** - All Black, **BZ** - All Bronze, **B** - Black w/White Ring, **C** - Chrome w/White Ring, **H** - Haze w/White Ring, **B\*** - All Black (For ELK3672)

# Compatible Products

For use with **Koto™** Architectural LED Light Engine

## 3" Pex™ Twist-On Trims

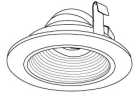

**Round Adjustable Baffle**

**ELK3693**  
Finishes:  
**(W)**

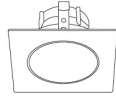

**Square Deep Reflector**

**ELK3318**  
Finishes:  
**(W, BB, BZ, B, C, H)**

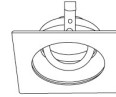

**Square Adjustable Reflector**

**ELK3329**  
Finishes:  
**(W, BB, BZ, B, C, H)**

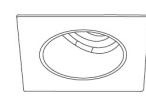

**Square Adj. Wall Wash**

**ELK3322**  
Finishes:  
**(W)**

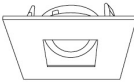

**Square Adjustable Pinhole**

**ELK3327**  
Finishes:  
**(W, BB, BZ, B, H)**

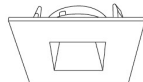

**Square Reflector**

**ELK3341**  
Finishes:  
**(W, BB, BZ, B)**

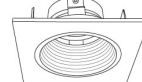

**Square Adjustable Baffle**

**ELK3393**  
Finishes:  
**(W)**

## 3" Pex™ Flush Mount Trim Adaptors

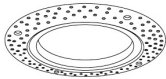

**Round Flush Mount Trim Adaptor**

**EL3FMR**

Compatible 3" Pex™ Round trims:  
ELK3618, ELK3629, ELK3627, ELK3693,  
ELK3620, ELK3622 Series

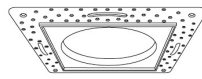

**Square Flush Mount Trim Adaptor**

**EL3FMS**

Compatible 3" Pex™ Square trims:  
ELK3318, ELK3329, ELK3322, ELK3327,  
ELK3341, ELK3393 Series

## 3" Pex™ Trimless

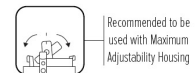

**Round Trimless Reflector**

**ELK308**  
Finishes:  
**(W, B, H)**



**Round Adjustable Trimless Reflector**

**ELK315**  
Finishes:  
**(W, B, H)**

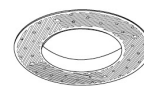

**Round Trimless Spackle Frame**

**EL3SFR**  
For use with ELK315



**Round Knife Edge Wood Ceiling Trim w/Mounting Clips**

**EL3WCR**  
Finishes:  
**(W, B)**



**Square Trimless Reflector**

**ELK370**  
Finishes:  
**(W, B, H)**



**Square Adjustable Trimless Reflector**

**ELK381**  
Finishes:  
**(W, B, H)**

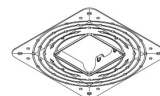

**Square Trimless Spackle Frame**

**EL03SFS**  
For use with ELK370 & ELK381

Finishes: **W** - All White, **BB** - All Black, **BZ** - All Bronze, **B** - Black w/White Ring, **C** - Chrome w/White Ring, **H** - Haze w/White Ring, **B\*** - All Black (For ELK315, ELK370, & ELK381)

# Compatible Products

For use with **Koto™ Architectural LED Light Engine**

## 4" Koto™ Architectural Recessed Housings

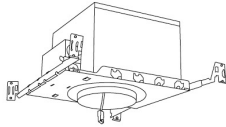

4" High Lumen Maximum Adjustability ICA Housing  
 1500 lm (15.7W) w/ELK21 Series Module  
 1650-1850 lm (15.7W) w/ELK24 Series Module  
**New Construction**

CAT NO.	SPECIFICATIONS
E4LK47ICA	120V - Triac/ELV
E4LK48ICAD	120/277V - 0-10V/Triac/ELV <sup>1</sup>
E4LK78ICA	120V - Triac/ELV
E4LK79ICAD	120/277V - 0-10V/Triac/ELV <sup>1</sup>

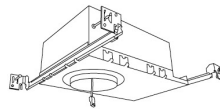

4" Shallow Maximum Adjustability ICA Housing  
 850 lm (14.7W) w/ELK19 Series Module  
 1100 lm (14.7W) w/ELK21 Series Module  
 1500 lm (14.7W) w/ELK24 Series Module  
**New Construction**

CAT NO.	SPECIFICATIONS
E4LK98ICA	120V - Triac/ELV
E4LK99ICAD	120/277V - 0-10V/Triac/ELV <sup>1</sup>



4" Standard ICA Housing  
 750 lm (11.8W) w/ELK19 Series Module  
 950 lm (11.8W) w/ELK21 Series Module  
 1350 lm (11.8W) w/ELK24 Series Module  
**New Construction**

CAT NO.	SPECIFICATIONS
E4LK87ICA	120V - Triac/ELV
E4LK87ICA-EM1	Emergency Battery Back-Up
E4LK88ICAD	120/277V - 0-10V/Triac/ELV <sup>1</sup>
E4LK88ICAD-EM1	Emergency Battery Back-Up



4" Standard ICA Housing  
 750 lm (11.8W) w/ELK19 Series Module  
 950 lm (11.8W) w/ELK21 Series Module  
 1350 lm (11.8W) w/ELK24 Series Module  
**Remodel**

CAT NO.	SPECIFICATIONS
E4LK87RICA	120V - Triac/ELV
E4LK88RICAD	120/277V - 0-10V/Triac/ELV <sup>1</sup>



2-Hour Fire Rated 4" ICA Housing  
 750 lm (11.8W) w/ELK19 Series Module  
 950 lm (11.8W) w/ELK21 Series Module  
 1100 lm (11.8W) w/ELK24 Series Module  
**New Construction**

CAT NO.	SPECIFICATIONS
ELK93FICA	120V - Triac/ELV
ELK94FICAD	120/277V - 0-10V/Triac/ELV <sup>1</sup>

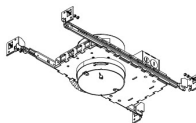

4" ICA Housing for 2-Hr Fire Rated Ceilings  
**New Construction**  
 Compatible Trims: ELK4116, ELK4127, ELK4129, ELK4188, ELK4710, ELK4713, ELK4715, ELK4216, ELK4229, ELK4227, ELK4714, & ELK4716

CAT NO.	SPECIFICATIONS
E4JB85ICA	120V - Triac/ELV
E4JB85ICA-EM1	Emergency Battery Back-Up
E4JB86ICAD	120/277V - 0-10V/Triac/ELV <sup>1</sup>
E4JB86ICAD-EM1	Emergency Battery Back-Up

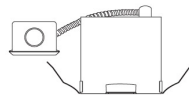

4" ICA Housing for 2-Hr Fire Rated Ceilings  
**Remodel**  
 Compatible Trims: ELK4116, ELK4127, ELK4129, ELK4188, ELK4710, ELK4713, ELK4715, ELK4216, ELK4229, ELK4227, ELK4714, & ELK4716

CAT NO.	SPECIFICATIONS
E4JB85RICA	120V - Triac/ELV
E4JB85RICA-EM1	Emergency Battery Back-Up
E4JB86RICAD	120/277V - 0-10V/Triac/ELV <sup>1</sup>
E4JB86RICAD-EM1	Emergency Battery Back-Up

<sup>1</sup> 3 in 1 dimming: Triac, ELV and 0-10V dimming in one driver to 1%

# Compatible Products

For use with Koto™ Architectural LED Light Engine

## 4" Pex™ Twist-On Trims

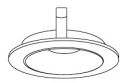

**Shallow Reflector**  
**ELK4116**  
Finishes:  
(W, H)



**Deep Reflector**  
**ELK4118**  
Finishes:  
(W, BB, BZ, B, C, H)



**Adjustable Reflector**  
**ELK4129**  
Finishes:  
(W, BB, BZ, B, C, H)



**Adjustable Reflector with Clear Glass**  
**ELK4111**  
Finishes:  
(W, BB, BZ, B, C, H)



**Adjustable Reflector with Frosted Lens**  
**ELK4112**  
Finishes:  
(W, BB, BZ, B, C, H)



**Rotatable Slot Aperture**  
**ELK4120**  
Finishes:  
(W)



**Adjustable Wall Wash**  
**ELK4122**  
Finishes:  
(W)



**Adjustable Pinhole**  
**ELK4127**  
Finishes:  
(W, BB, BZ, B, H)



**Adjustable Pinhole with Frosted Glass**  
**ELK4125**  
Finishes:  
(W, BB, BZ, B, H)



**Slot Aperture**  
**ELK4130**  
Finishes:  
(W)



**Adjustable Spot**  
**ELK4188**  
Finishes:  
(W, B, BZ)

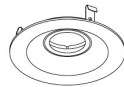

**Regressed Eyeball**  
**ELK4153**  
Finishes:  
(W, BB, B)

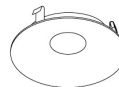

**Curved Reflector**  
**ELK4172**  
Finishes:  
(W, B)



**Directional Gimbal**  
**ELK4179**  
Finishes:  
(W, BB, B, H)

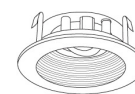

**Adjustable Baffle**  
**ELK4193**  
Finishes:  
(W, BB, B)

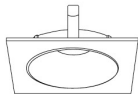

**Shallow Reflector**  
**ELK4216**  
Finishes:  
(W, H)

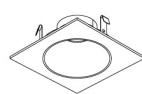

**Deep Reflector**  
**ELK4218**  
Finishes:  
(W, BB, BZ, B, C, H)

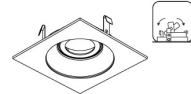

**Adjustable Gimbal**  
**ELK4229**  
Finishes:  
(W, BB, BZ, B, C, H)

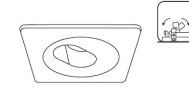

**Adjustable Slot Rotatable Aperture**  
**ELK4220**  
Finishes:  
(W)

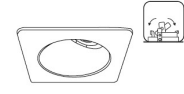

**Adjustable Wall Wash**  
**ELK4222**  
Finishes:  
(W)

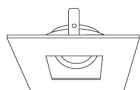

**Adjustable Pinhole**  
**ELK4227**  
Finishes:  
(W, BB, BZ, B, C, H)

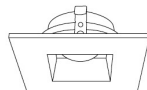

**Adjustable Reflector**  
**ELK4282**  
Finishes:  
(W, BZ)

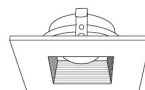

**Adjustable Baffle**  
**ELK4284**  
Finishes:  
(W, B, BZ)

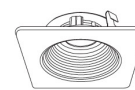

**Adj. Phenolic Baffle**  
**ELK4293**  
Finishes:  
(W, BB, B)

## 4" Pex™ Flush Mount Trim Adaptors

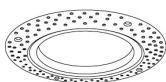

### Round Flush Mount Trim Adaptor

**EL4FMR**  
Compatible 3" Pex™ Round trims:  
ELK4116, ELK4118, ELK4127, ELK4129,  
ELK4710, ELK4713, ELK4715 Series

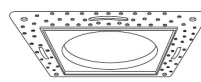

### Square Flush Mount Trim Adaptor

**EL4FMS**  
Compatible 3" Pex™ Square trims:  
ELK4216, ELK4218, ELK4227,  
ELK4229 Series

Finishes: **W** - All White, **BB** - All Black, **BZ** - All Bronze, **B** - Black w/White Ring, **C** - Chrome w/White Ring, **H** - Haze w/White Ring, **B\*** - All Black (For ELK4188, ELK4172, & ELK4284)

# Compatible Products

For use with **Koto™** Architectural LED Light Engine

## 4" Pex™ Trimless

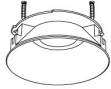

**Round Trimless Reflector**

**ELK408**  
Finishes:  
(W, B, H, BZ)



**Round Adj. Trimless Reflector**

**ELK415**  
Finishes:  
(W, B, H, BZ)

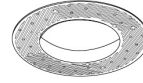

**Round Trimless Spackle Frame**

**EL4SFR**  
For use with ELK408 & ELK415

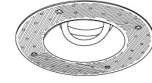

**Smooth Reflector**

**ELK430**  
Finishes:  
(W, B, BZ)

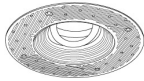

**Baffle**

**ELK434**  
Finishes:  
(W, B, BZ)

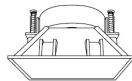

**Square Trimless Reflector**

**ELK445**  
Finishes:  
(W, B, H)

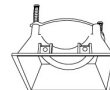

**Square Trimless Adj. Reflector**

**ELK459**  
Finishes:  
(W, B, H)

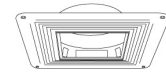

**Square Trimless Spackle Frame**

**EL4SFS**  
For use with ELK445 & ELK459

Finishes: **W** - All White, **BB** - All Black, **BZ** - All Bronze, **B** - Black w/White Ring, **C** - Chrome w/White Ring, **H** - Haze w/White Ring, **B\*** - All Black (For ELK408, ELK415, ELK434, ELK445, ELK459)

## 4" Flexa™ Twist-On Trims



**Round Reflector**

**ELK4721**  
Finishes:  
(WW, BB, BZBZ, BW, CW, HW)

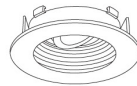

**Round Baffle**

**ELK4723**  
Finishes:  
(WW, BB, BZBZ, BW)

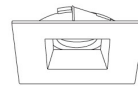

**Square Reflector**

**ELK4741**  
Finishes:  
(WW, BB, BZBZ, BW, HW)  
*\*Not for Remodel Housing*

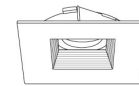

**Square Baffle**

**ELK4743**  
Finishes:  
(WW, BB, BZBZ, BW)  
*\*Not for Remodel Housing*

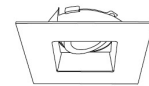

**Square Adj. Reflector**

**ELK4759**  
Finishes:  
(WW, BB, B, H)  
*\*Not for Remodel Housing*

## 4" Unique™ Twist-On Trims



**Round Adjustable Reflector**

**ELK4710**  
Finishes:  
(W, B, BZ)

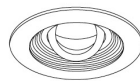

**Round Adjustable Baffle**

**ELK4713**  
Finishes:  
(W, BZ)

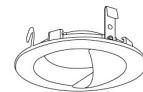

**Round Wall Wash**

**ELK4715**  
Finishes:  
(W, BZ)



**Round Adj. Deep Reflector**

**ELK4717**  
Finishes:  
(W, BZ)

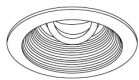

**Round Adj. Deep Baffle**

**ELK4719**  
Finishes:  
(W)

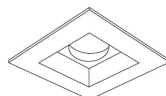

**Square Reflector**

**ELK4714**  
Finishes:  
(W, B, BZ)  
*\*Not for Remodel Housing*

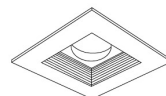

**Square Baffle**

**ELK4716**  
Finishes:  
(W, BZ)  
*\*Not for Remodel Housing*

\*Finishes: **W** - All White, **WW** - All White, **B** - Black Reflector w/White Ring, **C** - Chrome Reflector w/White Ring, **H** - Haze Reflector w/White Ring, **BB** - All Black, **BZ** - All Bronze, **CC** - All Chrome, **BZBZ** - All Bronze, **BW** - Black Reflector w/White Ring, **CW** - Chrome Reflector w/White Ring, **CN** - Chrome Reflector w/Nickel Ring, **HW** - Haze Reflector w/White Ring



# Compatible Products

For use with **Koto™** Architectural LED Light Engine

## 6" Koto™ Architectural Recessed Housings

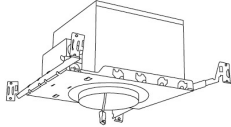

6" High Lumen Maximum Adjustability ICA Housing  
 1250 lm (15.9W) w/ELK21 Series Module  
 1650-1800 lm (18.9W) w/ELK24 Series Module  
**New Construction**

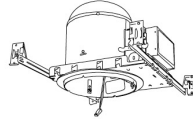

6" Standard ICA Housing  
 1100 lm (14.7W) w/ELK21 Series Module  
 1500 lm (14.7W) w/ELK24 Series Module  
**New Construction**

CAT NO.	SPECIFICATIONS
E6LK43ICA	120V - Triac/ELV
E6LK44ICAD	120/277V - 0-10V/Triac/ELV <sup>1</sup>
E6LK56ICA	120V - Triac/ELV
E6LK57ICAD	120/277V - 0-10V/Triac/ELV <sup>1</sup>

CAT NO.	SPECIFICATIONS
E6LK37ICA	120V - Triac/ELV
E6LK37ICA-EM1	Emergency Battery Back-Up
E6LK38ICAD	120/277V - 0-10V/Triac/ELV <sup>1</sup>
E6LK38ICAD-EM1	Emergency Battery Back-Up

## 5" & 6" Pex™ Twist-On Trims

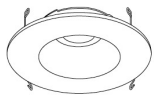

**5" Round Reflector**  
**ELK5421**  
 Finishes:  
 (W)

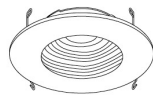

**5" Round Baffle**  
**ELK5493**  
 Finishes:  
 (W)

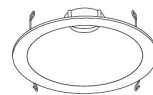

**6" Round Reflector**  
**ELK6418**  
 Finishes:  
 (W, BB, BZ, H)

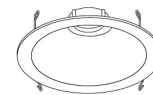

**6" Round Adj. Reflector**  
**ELK6429**  
 Finishes:  
 (W, BB, BZ, H)

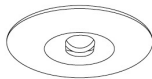

**6" Round Adj. Slot Aperture**  
**ELK6420W**  
 Finishes:  
 (W)

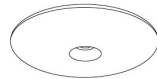

**6" Round Adj. Pinhole Reflector**  
**ELK6427**  
 Finishes:  
 (W, B, H)

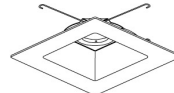

**6" Square Adj. Reflector**  
**ELK6829**  
 Finishes:  
 (W, BB, H)

## 6" Flexa™ Twist-On Trims



**6" Round Reflector**  
**ELK610**  
 Finishes:  
 (WW, BB, BZBZ, CC, BW, CW, HW)



**6" Round Adjustable Reflector**  
**ELK629**  
 Finishes:  
 (WW, BB, BZBZ, BW, CW, HW)



**6" Round Reflector**  
**ELK6710**  
 Finishes:  
 (W, B, BZ)

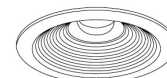

**6" Round Baffle**  
**ELK6713**  
 Finishes:  
 (W, BZ)

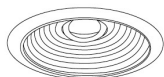

**6" Round Adjustable Baffle**  
**ELK693**  
 Finishes:  
 (WW, BB, BZBZ, BW)



**6" Round Wall Wash**  
**ELK6715**  
 Finishes:  
 (W, BZ)

## 6" Unique™ Twist-On Trims

Finishes: **W** - All White, **BB** - All Black, **BZ** - All Bronze, **B** - Black w/White Ring, **C** - Chrome w/White Ring, **H** - Haze w/White Ring, **B\*** - All Black (For ELK6710, ELK6713, ELK6715)

# Photometric Report

## Koto™ Architectural LED Module

### PHOTOMETRIC REPORT

Product #: ELK2127D  
 Wattage / Lumens: 12.22W / 1169.3 lm  
 Luminaire LPW: 95.7 lm/W

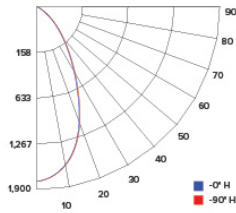

### CANDLE POWER SUMMARY

Degress Vertical	0°
0	1829
5	1737
15	1353
25	683
35	328
45	123
55	39
65	17
75	8
85	2
90	1

### ILLUMINANCE AT A DISTANCE

Distance to Target Plane	Center Beam Footcandles	Beam Diameter
4'	114	3.0'
6'	50.8	4.6'
8'	28.6	6.1'
10'	18.3	7.6'

### ZONAL LUMEN SUMMARY

Zone	Lumens	%Luminaire
0-30°	834.5	71.2
0-40°	1,022.9	87.3
0-60°	1,140.0	97.3
0-90°	1,164.3	99.4

### PHOTOMETRIC REPORT

Product #: ELK2130D  
 Wattage / Lumens: 12.22W / 1218 lm  
 Luminaire LPW: 99.6 lm/W

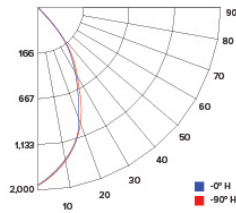

### CANDLE POWER SUMMARY

Degress Vertical	0°
0	1900
5	1805
15	1406
25	710
35	341
45	127
55	41
65	17
75	9
85	2
90	1

### ILLUMINANCE AT A DISTANCE

Distance to Target Plane	Center Beam Footcandles	Beam Diameter
4'	119	3.0'
6'	52.8	4.6'
8'	29.7	6.1'
10'	19.0	7.6'

### ZONAL LUMEN SUMMARY

Zone	Lumens	%Luminaire
0-30°	867.0	71.2
0-40°	1,062.8	87.3
0-60°	1,184.4	97.3
0-90°	1,209.7	99.4

### PHOTOMETRIC REPORT

Product #: ELK2135D  
 Wattage / Lumens: 12.22W / 1271 lm  
 Luminaire LPW: 104 lm/W

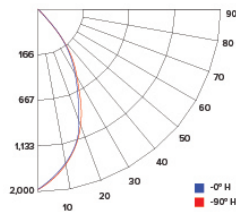

### CANDLE POWER SUMMARY

Degress Vertical	0°
0	1976
5	1877
15	1462
25	738
35	355
45	133
55	43
65	18
75	9
85	2
90	1

### ILLUMINANCE AT A DISTANCE

Distance to Target Plane	Center Beam Footcandles	Beam Diameter
4'	124	3.0'
6'	54.9	4.6'
8'	30.9	6.1'
10'	19.8	7.6'

### ZONAL LUMEN SUMMARY

Zone	Lumens	%Luminaire
0-30°	901.7	71.2
0-40°	1,105.3	87.3
0-60°	1,231.8	97.3
0-90°	1,258.1	99.4

### PHOTOMETRIC REPORT

Product #: ELK2140D  
 Wattage / Lumens: 12.22W / 1322 lm  
 Luminaire LPW: 108.2 lm/W

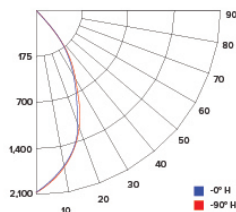

### CANDLE POWER SUMMARY

Degress Vertical	0°
0	2051
5	1948
15	1518
25	766
35	368
45	138
55	44
65	19
75	9
85	2
90	1

### ILLUMINANCE AT A DISTANCE

Distance to Target Plane	Center Beam Footcandles	Beam Diameter
4'	128	3.0'
6'	57.0	4.6'
8'	32.1	6.1'
10'	20.5	7.6'

### ZONAL LUMEN SUMMARY

Zone	Lumens	%Luminaire
0-30°	935.9	71.2
0-40°	1,147.2	87.3
0-60°	1,278.5	97.3
0-90°	1,305.8	99.4

# Photometric Report

## Koto™ Architectural LED Module

### PHOTOMETRIC REPORT

Product #: ELK2130D-W (E4LK79ICAD)  
 Wattage / Lumens: 17.9W / 1584.3 lm  
 Luminaire LPW: 88.5 lm/W

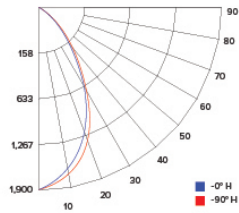

### CANDLE POWER SUMMARY

Degree Vertical	0°
0	1880
5	1753
15	1396
25	892
35	399
45	170
55	50
65	21
75	11
85	6
90	5

### ILLUMINANCE AT A DISTANCE

Distance to Target Plane	Center Beam Footcandles	Beam Diameter
4'	118	3.9'
6'	52.2	5.9'
8'	29.4	7.9'
10'	18.8	9.8'

### ZONAL LUMEN SUMMARY

Zone	Lumens	%Luminaire
0-30°	1,042.6	65.8
0-40°	1,346.3	85
0-60°	1,545.5	97.6
0-90°	1,584.0	100

### PHOTOMETRIC REPORT

Product #: ELK2135D-W (E4LK79ICAD)  
 Wattage / Lumens: 17.9W / 1647.3 lm  
 Luminaire LPW: 92 lm/W

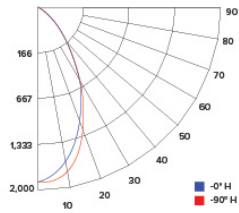

### CANDLE POWER SUMMARY

Degree Vertical	0°
0	1955
5	1824
15	1452
25	928
35	415
45	177
55	52
65	21
75	11
85	6
90	5

### ILLUMINANCE AT A DISTANCE

Distance to Target Plane	Center Beam Footcandles	Beam Diameter
4'	122	3.9'
6'	54.3	5.9'
8'	30.6	7.9'
10'	19.6	9.8'

### ZONAL LUMEN SUMMARY

Zone	Lumens	%Luminaire
0-30°	1,084.3	65.8
0-40°	1,400.1	85
0-60°	1,607.3	97.6
0-90°	1,647.4	100