

Canless Koto™ LED Module

Designed to be installed without a recessed housing. Works with New Construction Frames or Remodel Power Packs and Koto™ Twist-On Trims.



Features

- IC Rated for direct contact with insulation
- Canless Module works with Koto™ frames and power packs
- Driver specified for 120V (Triac/ELV) or 120/277V (0-10V/Triac/ELV) dimming
- Works in 2", 3", 4" and 6" Canless Koto™ twist-on trims
- Push-&-Twist connector on module for easy installation
- Standard 38° Lens installed, 25° and 60° lens included with each module - Optional Lens:
18° (EP731C), 90° (EP739C)
- Optional: Louver (L45), Linear Lens (L46), Spread Lens (L47), Clear Lens (L48), Frosted Lens (L49), White Koto Snoot (L50W), Black Koto Snoot (L50B), Color Shifter (L51), Blue Lens (L52), Pink Lens (L53), Single Asymmetric Lens (L54), Double Asymmetric Lens (L55)
- Excellent color rendering 95+ CRI
- Offered in 2700K, 3000K, 3500K, 4000K, Sunset Dimming (Dims from 3000K to 1800K), & Human Centric (Dims from 4000K to 2200K)
- Title 24 JA8-2022 Compliant
- Life span of 50,000 hours L70
- Covered by U.S. PATENTS and Patents Pending

Specifications

Wattage	10.5 MAXW
Lumens	Up to 950 lm
Color Temp.	4000K
Lamp Type	LED
Beam Angle	90°
CRI	95
Wet Location	cUL Listed w/Wet Location Trim
Damp Location	cUL Listed

Dimensions



Product Number

Item	Lamp type	Lumens	CCT	Watts	Beam Angle
EKCL2140D-E	LED	Up to 950 lm	4000K	10.5 MAX	90°

Technical Details

Optics: PC lens diffuses light evenly throughout while reducing glare with LED COB technology.

Construction: Diecast aluminum body with heat fins allow for efficient cooling.

Installation: Twist-On design for toolless trim installation, for use with Canless Koto™ trims only. Can be use with New Construction Frames or Remodel IC Power Packs.

LED Technology: Extremely accurate Color Rendering Index (CRI) of 95+. Lumen Maintaince of 50,000 hours L70 Life based on LM80 standardized test results. Superior Thermal Management by utilizing integrated heat sink. Instant On to Full Brightness. No LED pixilation.

Sunset: Sunset color temperature is our dim-to-warm LED technology that allows the color temperature to become warmer as the product is dimmed. Our SUNSET items start at 3000K and go as low as 1800K when dimmed. For Sunset dim technology be sure to order an item with "Sunset (SDD)" in the Color Temperature (CCT) attribute.

Human Centric: Our HUMAN CENTRIC items start at 4000K and go as low as 2200K when dimmed. For Human Centric dim technology be sure to order an item with "Human Centric (HCD)" in the Color Temperature (CCT) attribute.

Listings: cUL Listed for Damp Locations and Wet Location with Wet location trims. RoHS Compliant. Title 24 JA8-2022 E-Compliant.

Warranty: ELCO Products are built to last with a 5-year Limited Warranty.

Product Number Builder Example: EKCL2127D

Canless Koto™ LED Module	Lumens (Watts)	Color Temp.	Beam Angle
EKCL	21 Up to 950 lm (10.5W MAX)	27D 2700K 30D 3000K 35D 3500K 40D 4000K SDD Sunset ¹ HCD Human Centric ²	38° ³ -S 18° -N 25° -W 60° -E 90° ⁴

¹ Sunset, Dim to Warm technology, automatically transitions from 3000K to 1800K when dimmed

² Human Centric, Dim to Warm technology, automatically transitions from 4000K to 2200K when dimmed

³ 38° lens installed. Includes 25° and 60° lens with module.

⁴ 90° Frosted Reflector

Compatible Products



For use with **Canless Koto™ LED Module**

2" Canless Koto™ LED Frames & Power Packs

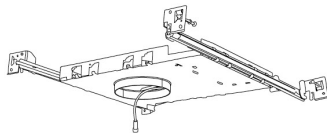

2" Canless Koto™
IC Frame
New Construction



Canless Koto™
IC Power Pack
Remodel

CAT NO.	SPECIFICATIONS	CAT NO.	SPECIFICATIONS
E2KCL10IC	120V, Triac/ELV	EKCL10RIC	120V, Triac/ELV
E2KCL10IC-EM1	90 min. Emergency Battery Backup	EKCL10RIC-EM1	90 min. Emergency Battery Backup
E2KCL10ICDX	120/277V - 0-10V/Triac/ELV	EKCL10RICDX	120/277V - 0-10V/Triac/ELV
E2KCL10ICDX-EM1	90 min. Emergency Battery Backup	EKCL10RICDX-EM1	90 min. Emergency Battery Backup

2" Pex™ Twist-On Trims



Round Deep Reflector
EKCL2818
Finishes:
(W, B, H, BB, BZ)



Round Adjustable Reflector
EKCL2829
Finishes:
(W, B, H, BB, BZ)

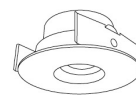

Round Adjustable Pinhole
EKCL2827
Finishes:
(W, B, BB, BZ)



Round Curved Reflector
EKCL2872
Finishes:
(W, B*)

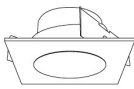

Square Deep Reflector
EKCL2518
Finishes:
(W, B, BB)

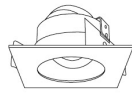

Square Adjustable Reflector
EKCL2529
Finishes:
(W, B, BB)

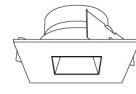

Square Reflector
EKCL2541
Finishes:
(W, B, BB)

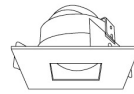

Square Adjustable Pinhole
EKCL2527
Finishes:
(W, B, BB)



Round Gimbal
EKCL2888
Finishes:
(W, B*, BZ)

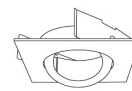

Square Gimbal
EKCL2588
Finishes:
(W, B*, BZ)



Round Adj. Trimless Reflector
ELK215
Finishes:
(W, B*)

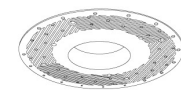

Trimless Spackle Frame
EL2SFR
For use with ELK215

2" Pex™ Trimless

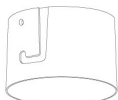

Adjustable Trimless Reflector
ELK215
Finishes:
(W, B)



Round Trimless Spackle Frame
EL2SFR
Ordered Separately

Finishes: **W** - All White, **BB** - All Black, **BZ** - All Bronze, **B** - Black w/White Ring, **C** - Chrome w/White Ring, **H** - Haze w/White Ring, **B*** - All Black (For ELK2872, ELK2888, ELK2588, & ELK215)

Compatible Products

For use with **Canless Koto™ LED Module**

3" Canless LED Koto™ Frames & Power Packs

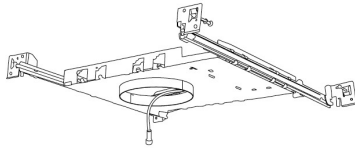

3" Canless Koto™
IC Frame
New Construction

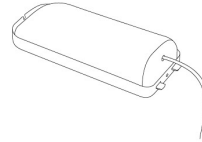

Canless Koto™
IC Power Pack
Remodel

CAT NO.	SPECIFICATIONS	CAT NO.	SPECIFICATIONS
E3KCL10IC	120V, Triac/ELV	EKCL10RIC	120V, Triac/ELV
E3KCL10IC-EM1	90 min. Emergency Battery Backup	EKCL10RIC-EM1	90 min. Emergency Battery Backup
E3KCL10ICDX	120/277V - 0-10V/Triac/ELV	EKCL10RICDX	120/277V - 0-10V/Triac/ELV
E3KCL10ICDX-EM1	90 min. Emergency Battery Backup	EKCL10RICDX-EM1	90 min. Emergency Battery Backup

3" Pex™ Twist-On Trims



Round Deep Reflector
EKCL3618
Finishes:
(W, BB, BZ, B, C, H)

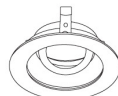

Round Adjustable Gimbal
EKCL3629
Finishes:
(W, BB, BZ, B, C, H)

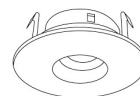

Round Adjustable Pinhole
EKCL3627
Finishes:
(B, BB, BZ, B, H)



Round Adj. Slot Aperture
EKCL3620
Finishes:
(W)



Round Adj. Wall Wash
EKCL3622
Finishes:
(W)

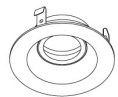

Round Regressed Eyeball
EKCL3653
Finishes:
(W, BB, B)

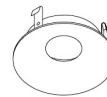

Round Curved Reflector
EKCL3672
Finishes:
(W, B)

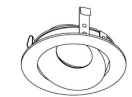

Round Directional Gimbal
EKCL3679
Finishes:
(W, BB, B, H)



Round Adjustable Baffle
EKCL3693
Finishes:
(W)

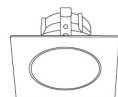

Square Deep Reflector
EKCL3318
Finishes:
(W, BB, BZ, B, C, H)

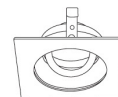

Square Adjustable Reflector
EKCL3329
Finishes:
(W, BB, BZ, B, C, H)

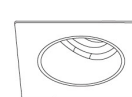

Square Adj. Wall Wash
EKCL3322
Finishes:
(W)



Square Adjustable Pinhole
EKCL3327
Finishes:
(W, BB, BZ, B, H)

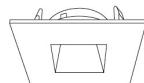

Square Reflector
EKCL3341
Finishes:
(W, BB, BZ, B)

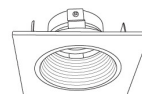

Square Adjustable Baffle
EKCL3393
Finishes:
(W)

*Finishes: **W** - All White, **BB** - All Black, **BZ** - All Bronze, **B** - Black Reflector w/White Ring, **C** - Chrome Reflector w/White Ring, **H** - Haze Reflector w/White Ring

Compatible Products

For use with **Canless Koto™ LED Module**

3" Pex™ Flush Mount Trim Adaptors

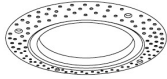

Round Flush Mount Trim Adaptor

EL3FMR

Compatible 3" Pex™ Round trims:
ELK3618, ELK3629, ELK3627, ELK3693,
ELK3620, ELK3622 Series

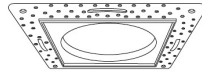

Square Flush Mount Trim Adaptor

EL3FMS

Compatible 3" Pex™ Square trims:
ELK3318, ELK3329, ELK3322, ELK3327,
ELK3341, ELK3393 Series

3" Pex™ Trimless



Round Trimless Reflector

ELK308

Finishes:
(W, B, H)



Round Adjustable Trimless Reflector

ELK315

Finishes:
(W, B, H)



Round Trimless Spackle Frame

EL3SFR

For use with ELK315



Round Knife Edge Wood Ceiling Trim w/Mounting Clips

EL3WCR

Finishes:
(W, B)



Square Trimless Reflector

ELK370

Finishes:
(W, B, H)



Square Adjustable Trimless Reflector

ELK381

Finishes:
(W, B, H)



Square Trimless Spackle Frame

EL03SFS

For use with ELK370 & ELK381

Finishes: **W** - All White, **BB** - All Black, **BZ** - All Bronze, **B** - Black w/White Ring, **C** - Chrome w/White Ring, **H** - Haze w/White Ring, **B*** - All Black (For ELK315, ELK370, & ELK381)

Compatible Products



For use with **Canless Koto™ LED Module**

4" Canless Koto™ LED Frames & Power Packs

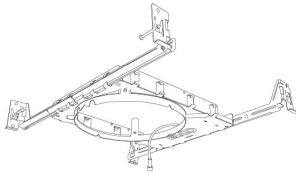

4" Canless Koto™
IC Frame
New Construction

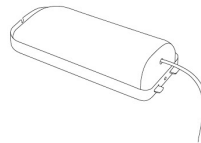

Canless Koto™
IC Power Pack
Remodel

CAT NO.	SPECIFICATIONS	CAT NO.	SPECIFICATIONS
E4KCL10IC	120V, Triac/ELV	EKCL10RIC	120V, Triac/ELV
E4KCL10IC-EM1	90 min. Emergency Battery Backup	EKCL10RIC-EM1	90 min. Emergency Battery Backup
E4KCL0ICDX	120/277V - 0-10V/Triac/ELV	EKCL10RICDX	120/277V - 0-10V/Triac/ELV
E4KCL10ICDX-EM1	90 min. Emergency Battery Backup	EKCL10RICDX-EM1	90 min. Emergency Battery Backup

4" Pex™ Twist-On Trims



Shallow Reflector
EKCL4116
Finishes:
(W, H)



Deep Reflector
EKCL4118
Finishes:
(W, BB, BZ, B, C, H)



Adjustable Reflector
EKCL4129
Finishes:
(W, BB, BZ, B, C, H)



Adjustable Reflector with Clear Glass
EKCL4111
Finishes:
(W, BB, BZ, B, C, H)



Adjustable Reflector with Frosted Lens
EKCL4112
Finishes:
(W, BB, BZ, B, C, H)



Rotatable Slot Aperture
EKCL4120
Finishes:
(W)



Adjustable Wall Wash
EKCL4122
Finishes:
(W)



Adjustable Pinhole
EKCL4127
Finishes:
(W, BB, BZ, B, H)



Adjustable Pinhole with Frosted Glass
EKCL4125
Finishes:
(W, BB, BZ, B, H)



Slot Aperture
EKCL4130
Finishes:
(W)



Adjustable Spot
EKCL4188
Finishes:
(W, B, BZ)



Regressed Eyeball
EKCL4153
Finishes:
(W, BB, B)



Curved Reflector
EKCL4172
Finishes:
(W, B)



Directional Gimbal
EKCL4179
Finishes:
(W, BB, B, H)

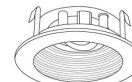

Adjustable Baffle
EKCL4193
Finishes:
(W, BB, B)

Finishes: **W** - All White, **BB** - All Black, **BZ** - All Bronze, **B** - Black w/White Ring, **C** - Chrome w/White Ring, **H** - Haze w/White Ring, **B*** - All Black (For ELK4188, ELK4172, & ELK4284)

Compatible Products

For use with **Canless Koto™ LED Module**

4" Pex™ Twist-On Trims

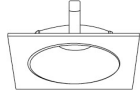

Shallow Reflector

EKCL4216
Finishes:
(W, H)

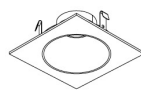

Deep Reflector

EKCL4218
Finishes:
(W, BB, BZ, B, C, H)

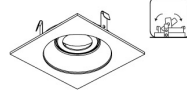

Adjustable Gimbal

EKCL4229
Finishes:
(W, BB, BZ, B, C, H)

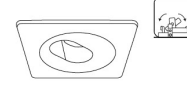

**Adjustable Slot
Rotatable Aperture**

EKCL4220
Finishes:
(W)

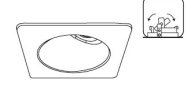

**Adjustable
Wall Wash**

EKCL4222
Finishes:
(W)

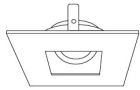

Adjustable Pinhole

EKCL4227
Finishes:
(W, BB, BZ, B, C, H)

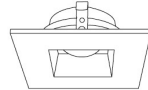

Adjustable Reflector

EKCL4282
Finishes:
(W, BZ)

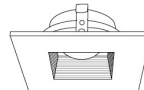

Adjustable Baffle

EKCL4284
Finishes:
(W, B, BZ)

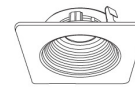

Adj. Phenolic Baffle

EKCL4293
Finishes:
(W, BB, B)

4" Pex™ Flush Mount Trim Adaptors

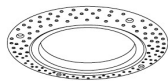

Round Flush Mount Trim Adaptor

EL4FMR
Compatible 3" Pex™ Round trims:
ELK4116, ELK4118, ELK4127, ELK4129,
ELK4710, ELK4713, ELK4715 Series

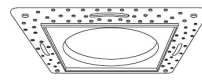

Square Flush Mount Trim Adaptor

EL4FMS
Compatible 3" Pex™ Square trims:
ELK4216, ELK4218, ELK4227,
ELK4229 Series

4" Pex™ Trimless



Round Trimless Reflector

ELK408
Finishes:
(W, B, H, BZ)



Round Adj. Trimless Reflector

ELK415
Finishes:
(W, B, H, BZ)

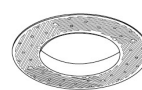

Round Trimless Spackle Frame

EL4SFR
For use with ELK408 & ELK415

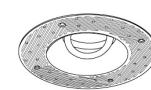

Smooth Reflector

ELK430
Finishes:
(W, B, BZ)



Baffle

ELK434
Finishes:
(W, B, BZ)

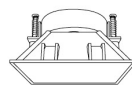

Square Trimless Reflector

ELK445
Finishes:
(W, B, H)

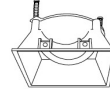

Square Trimless Adj. Reflector

ELK459
Finishes:
(W, B, H)

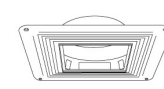

Square Trimless Spackle Frame

EL4SFS
For use with ELK445 & ELK459

Finishes: **W** - All White, **BB** - All Black, **BZ** - All Bronze, **B** - Black w/White Ring, **C** - Chrome w/White Ring, **H** - Haze w/White Ring, **B*** - All Black (For ELK408, ELK415, ELK434, ELK445, ELK459)

Compatible Products

For use with **Canless Koto™ LED Module**

4" Flexa™ Twist-On Trims

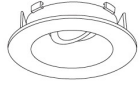

Round Reflector

EKCL4721
 Finishes:
 (WW, BB, BZBZ,
 BW, CW, HW)

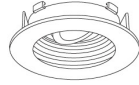

Round Baffle

EKCL4723
 Finishes:
 (WW, BB, BZBZ, BW)

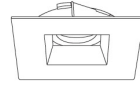

Square Reflector

EKCL4741
 Finishes:
 (WW, BB, BZBZ,
 BW, HW)
**Not for Remodel Housing*

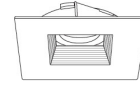

Square Baffle

EKCL4743
 Finishes:
 (WW, BB, BZBZ, BW)
**Not for Remodel Housing*

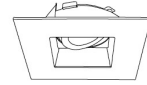

Square Adj. Reflector

EKCL4759
 Finishes:
 (WW, BB, B, H)
**Not for Remodel Housing*

4" Unique™ Twist-On Trims



Round Adjustable Reflector

EKCL4710
 Finishes:
 (W, B, BZ)

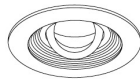

Round Adjustable Baffle

EKCL4713
 Finishes:
 (W, BZ)

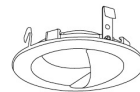

Round Wall Wash

EKCL4715
 Finishes:
 (W, BZ)

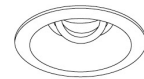

Round Adj. Deep Reflector

EKCL4717
 Finishes:
 (W, BZ)

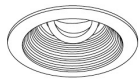

Round Adj. Deep Baffle

EKCL4719
 Finishes:
 (W)

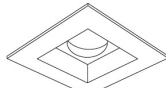

Square Reflector

EKCL4714
 Finishes:
 (W, B, BZ)
**Not for Remodel Housing*

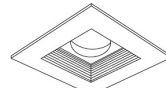

Square Baffle

EKCL4716
 Finishes:
 (W, BZ)
**Not for Remodel Housing*

*Finishes: **W** - All White, **WW** - All White, **B** - Black Reflector w/White Ring, **C** - Chrome Reflector w/White Ring, **H** - Haze Reflector w/White Ring, **BB** - All Black, **BZ** - All Bronze, **CC** - All Chrome, **BZBZ** - All Bronze, **BW** - Black Reflector w/White Ring, **CW** - Chrome Reflector w/White Ring, **CN** - Chrome Reflector w/Nickel Ring, **HW** - Haze Reflector w/White Ring

Compatible Products



For use with **Canless Koto™ LED Module**

6" Canless Koto™ LED Frames & Power Packs

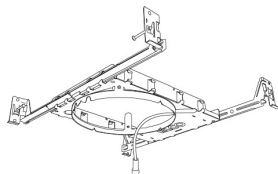

6" Canless Koto™
IC Frame
New Construction

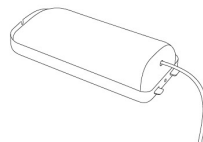

Canless Koto™
IC Power Pack
Remodel

CAT NO.	SPECIFICATIONS	CAT NO.	SPECIFICATIONS
E6KCL10IC	120V, Triac/ELV	EKCL10RIC	120V, Triac/ELV
E6KCL10IC-EM1	90 min. Emergency Battery Backup	EKCL10RIC-EM1	90 min. Emergency Battery Backup
E6KCL10ICDX	120/277V - 0-10V/Triac/ELV	EKCL10RICDX	120/277V - 0-10V/Triac/ELV
E6KCL10ICDX-EM1	90 min. Emergency Battery Backup	EKCL10RICDX-EM1	90 min. Emergency Battery Backup

5" & 6" Pex™ Twist-On Trims



5" Round Reflector
EKCL5421
Finishes:
(W)

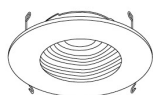

5" Round Baffle
EKCL5493
Finishes:
(W)



6" Round Reflector
EKCL6418
Finishes:
(W, BB, BZ, H)



6" Round Adj. Reflector
EKCL6429
Finishes:
(W, BB, BZ, H)

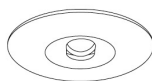

6" Round Adj. Slot Aperture
EKCL6420W
Finishes:
(W)

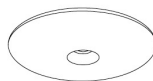

6" Round Adj. Pinhole Reflector
EKCL6427
Finishes:
(W, B, H)

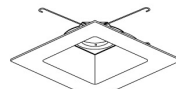

6" Square Adj. Reflector
EKCL6829
Finishes:
(W, BB, H)

6" Flexa™ Twist-On Trims



6" Round Reflector
EKCL610
Finishes:
(WW, BB, BZBZ, CC, BW, CW, HW)



6" Round Adjustable Reflector
EKCL629
Finishes:
(WW, BB, BZBZ, BW, CW, HW)



6" Round Reflector
EKCL6710
Finishes:
(W, B, BZ)

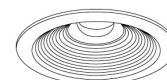

6" Round Baffle
EKCL6713
Finishes:
(W, BZ)



6" Round Adjustable Baffle
EKCL693
Finishes:
(WW, BB, BZBZ, BW)



6" Round Wall Wash
EKCL6715
Finishes:
(W, BZ)

Finishes: **W** - All White, **BB** - All Black, **BZ** - All Bronze, **B** - Black w/White Ring, **C** - Chrome w/White Ring, **H** - Haze w/White Ring, **B*** - All Black (For ELK6710, ELK6713, ELK6715)

6" Unique™ Twist-On Trims



ELCO Lighting

Dimmer Compatibility Chart

120V - Triac/ELV Dimmers

For Canless Koto™ System

E2KCL10IC, E3KCL10IC, E4KCL10IC, E6KCL10IC, and EKCL10RIC

For Reference Only

Testing conducted by ELCO Lighting is not a substitute for and does not imply certification by an independent laboratory or any other standards certification. Refer to manufacturer specifications for more detailed information on product certifications and standards. Consult the dimmer manufacturer prior to installation to ensure compatibility.

Manufacturer	Product	Part Number	Dimmed Light Output Range
Leviton	Decora SureSlide® Single Pole with Slide -to-Off	6672	15% - 100%
	Leviton Dimmer	1K3502	5% - 100%
Lutron	Vive, 120V, 150W LED/CFL, 600W Incandescent/Halogen, FP, Single Pole/Multi-Location Dimmer, Commercial Application	MRF2S-6CL	12% - 91%
	Panel Model, Commercial/Residential Application, FP	GP (Harrier) Card	10% - 94%
	Grafik QS/Mailbox Power Module, 120/220 to 240V AC, LED/Incandescent/Halogen Load Type, Commercial/Residential Indoor Application, FP	LQRJ-WPM-6P	10% - 95%
	Grafik Eye 3000/HomeWorks, 120V, Incandescent/Fluorescent Load Type, Commercial/Residential Application, FP	HWI-WPM-6D-120	10% - 95%
	Panel Dimming Module, 120V, Commercial/Residential Application, FP	HW/LP-RPM-4U-120	10% - 95%
	Panel Adaptive Dimming Module, 120V, Commercial/Residential Application, FP	HW/LP-RPM-4A-120	9% - 95%
	HomeWorks® QS for CFL/LED loads, 120V, RP, Commercial/Residential Application	LQSE-4A1-D/MQSE-4A1-D/ MQSE-3A1/MQSE-2A1-D	8% - 95%
	Energi Savr Node LED+ Phase Adaptive, Commercial Application, Reverse Phase, (Zone 1) (Zones 2-4)	QSN-4A5-S	8% - 95%
	RadioRA®2, 120V, 50/60-Hz, 150W LED or 600W Incandescent/Halogen, 3-Way & 4-Way, Residential Application	RRD-6CL	10% - 95%
	RadioRA®3, 120V, 250W LED/CFL or 500W Incandescent/Halogen, Single Pole, Multi-Location	RRST-PRO-N	10% - 95%
	HomeWorks® QS, 120V, 60-Hz, 150W LED/CFL or 600W Incandescent/Halogen/MLV, Residential Application	HQRD-6CL(H2) HQRA-6CL(H2)	10% - 95%
	Homeworks QS, Residential Application, Reverse Phase	LQSE-4A-120-D	8% - 89%
	HomeWorks® for LED/Incandescent/Halogen loads, Reverse Phase, (Zone 1) (Zones 2-4)	LQSE-4A5-120-D	8% - 89%
	Ariadni® C-L Single Pole/3-Way, 150W LED/CFL or 600W Incandescent/Halogen	AYCL-153P	10% - 100%
	Skylark Contour® C-L, Single Pole/3-Way, 150W LED/CFL or 600W Incandescent/Halogen	CTCL-153P	10% - 100%
	Skylark® C-L Single Pole/3-Way, 150W LED/CFL or 600W Incandescent/Halogen	SCL-153P	10% - 100%
	Diva® Series 150W Single Pole/3-Way Dimmer	DVCL-153P	10% - 100%
Skylark Contour® Single Pole/3-Way 1000W Incandescent/Halogen	CT-103P	10% - 100%	

Integrating our lighting with your Smart Home System is a breeze. Simply check your Smart Home system for compatible smart switches and cross reference that with our Dimming Compatibility Chart. Once the switches are integrated with your Smart Home system your lights will be ready to go.



2042 E. Vernon Ave. Vernon CA 90058 Tel 323.231.2600 Fax 323.231.3200 elcolighting.com

RV 06.24

Manufacturer	Product	Part Number	Dimmed Light Output Range
Lutron	Skylark® Single Pole 300W ELV Preset Dimmer	SELV-300P	5% - 100%
	Skylark® Single Pole 600W Incandescent/Halogen, Slide-to-Off Dimmer	S-600P	5% - 100%
	Diva® 300W Single Pole/3-Way ELV Dimmer	DVELV-303P	10% - 100%
	Diva® 600W Single Pole Incandescent/Halogen Preset Dimmer	DV-600P	5% - 100%
	Ariadni® 600W Single Pole Magnetic Low Voltage Dimmer	AYLV-600P	5% - 100%
	Ariadni® 600W Single Pole/3-Way Incandescent/Halogen Dimmer	AY-603P	5% - 100%
	Maestro® 600W Single Pole/3-Way ELV Dimmer	MAELV-600	5% - 100%
	Maestro® C-L Single Pole/3-Way Dimmer. 150W Max for LED/CFL or 600W Max for Incandescent/Halogen	MACL-153M	10% - 100%
	Caséta® Wireless Dimmer	PD-6WCL	10% - 100%

***NOTE: Refer to dimmer manufacturer's documentation for installation instructions and circuit details**

Disclaimer: Minimum and maximum loads for LEDs and CFLs are given in number of lamps and may vary depending on the lamp being used. Testing conducted by ELCO Lighting is not a substitute for and does not imply certification by an independent laboratory or any other standards certification. Refer to manufacturer specifications for more detailed information on product certifications and standards.

Integrating our lighting with your Smart Home System is a breeze. Simply check your Smart Home system for compatible smart switches and cross reference that with our Dimming Compatibility Chart. Once the switches are integrated with your Smart Home system your lights will be ready to go.

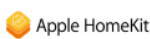



ELCO Lighting

Dimmer Compatibility Chart
120/277V - 0-10V/Triac/ELV Dimmers
For Canless Koto™ System
E2KCL10ICDX, E3KCL10ICDX, E4KCL10ICDX, E6KCL10ICDX,
and EKCL10RICDX

For Reference Only

Testing conducted by ELCO Lighting is not a substitute for and does not imply certification by an independent laboratory or any other standards certification. Refer to manufacturer specifications for more detailed information on product certifications and standards. Consult the dimmer manufacturer prior to installation to ensure compatibility. The listed values were measured under ideal conditions in a test lab. Results in the field may differ.

Table with 4 columns: Manufacturer, Product, Part Number, Dimmed Light Output Range. Rows include manufacturers like Lutron, Leviton, Eaton, Cooper, and Lightolier with various dimmer models and their specifications.

Integrating our lighting with your Smart Home System is a breeze. Simply check your Smart Home system for compatible smart switches and cross reference that with our Dimming Compatibility Chart. Once the switches are integrated with your Smart Home system your lights will be ready to go.

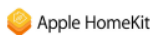

Manufacturer	Product	Part Number	Dimmed Light Output Range
0-10V Type Dimmers - 120/277V			
Lutron	120/277V AC, 0-10V LED/CFL Ballast, Single Pole, 3-Way	NFTV	1% - 100%
	120/277V AC, 0-10V, Single Pole, 3-Way, Commercial and Residential, Indoor Application	DVSTV	1% - 100%
	120/277V AC 50/60Hz, 0-10V LED/CFL Ballast, Single Pole, 3-Way, Indoor Application	DVTV	1% - 100%
Leviton	120/277V AC 60Hz, 0-10V LED/CFL Ballast, Single Pole, 3-Way	IP710-DL	1% - 100%

***NOTE: Refer to dimmer manufacturer’s documentation for installation instructions and circuit details**

Disclaimer: Minimum and maximum loads for LEDs and CFLs are given in number of lamps and may vary depending on the lamp being used. Testing conducted by ELCO Lighting is not a substitute for and does not imply certification by an independent laboratory or any other standards certification. Refer to manufacturer specifications for more detailed information on product certifications and standards.

Integrating our lighting with your Smart Home System is a breeze. Simply check your Smart Home system for compatible smart switches and cross reference that with our Dimming Compatibility Chart. Once the switches are integrated with your Smart Home system your lights will be ready to go.

