

8" New Construction Plaster Frame with Driver



Features

- Optional 90 minutes, 120/277 VAC, 60Hz Emergency Backup.
- USA designed and assembled.
- LED Light Engine sold separately (see Compatible Products).
- 2 at the end of the item number denotes Generation 2. Please note Gen 2 and Gen 1 are not cross compatible.

Specifications

Lumens	4000 lm
Voltage	120V
Dimmable	Lutron
Power Factor	≥0.9
Damp Location	Listed

Options



Optional EM Battery Back-up

Technical Details

Construction:

Constructed from 16 gauge galvanized steel for commercial building applications.

Installation:

High strength hanger bars can easily be nailed to joists. Suitable for T-grid and drop ceiling applications. See installation sheet for detailed information.

Junction Box: Positioned to accommodate straight conduit runs. Seven 1/2" trade size conduit knockouts and four pry-out knockout slots for easy romex installation.

Hanger Bars: Pre Installed hanger bars with True Nail easy installation in regular lumber, engineered lumber, and Laminated Beams. Integral T-bar slots for easy installation in T-Bars. Spans up 24" and can be repositioned 90°. Score lines allow for tool-free hanger bar size reduction. Integral leveling flange allows for single-person installation while easily aligning the housings with the joists.

Electrical:

- Driver is rated for 120V and 277V input (120/277V).
- High Efficiency driver with a power factor > 0.9.
- Can be specified with Lutron drivers for specific applications.

Dimmability:

- 3 in 1 dimming: Triac, ELV and 0-10V dimming in one driver.
- 0-10V dimming down to 5% with a compatible dimmer.
- Flicker-Free Dimming.
- Can be specified with Lutron drivers for 0.1% and 1% dimming.
- For a full list of dimmers refer to the Dimmer Compatibility List.

Listings: cULus Listed for Damp Location. cULus Listed for Wet Location with select trims. cULus Listed for Direct Contact with Insulation and Combustible Material for units up to 2000 lm. cULus Listed for Feed Through.

Warranty: ELCO Products are built to last. 5-year Limited warranty.

Dimensions

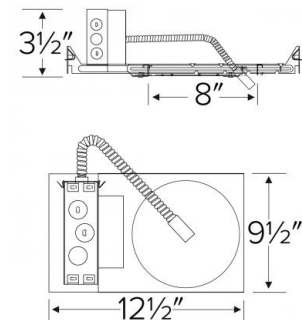

Product Number

Item	Lumens	Voltage	Dimming
E8LFU40L2	4000 lm	120V	Lutron

Product Number Builder

Example: **E8LFU08D2**

ELCO Laurel 8"
Plaster Frame

E8LF

Voltage

U 120/277V

Lumens

- 08** 850 lm
- 12** 1250 lm
- 16** 1600 lm
- 20** 2000 lm
- 30** 3000 lm
- 40** 4000 lm
- 60** 6000 lm

Dimming

- D** Triac/ELV/0-10V
- S** Sunset
- L** Lutron

Generation

- 2** Gen 2
- Gen 1

Optional

- No EM
- EM1** 8W Emer. Backup
- EM2** 12W Emer. Backup

Compatible Products



For use with 8" Laurel™ Frames

8" Laurel™ Commercial LED Light Engines



Reflector Trim
E810L



Wall Wash Trim
E811L



Drop Glass Trim
E812L



Adjustable Trim
E818L

PRODUCT NUMBER BUILDER

Laurel™ Trim	Lumen	Color Temperature	Finish	Generation
<input type="text"/>	<input type="text"/>	<input type="text"/>	<input type="text"/>	<input type="text"/>
E810L Reflector	08 850 lm	27 2700K	W All White	(blank) Gen 1
E811L Wall Wash	12 1250 lm	30 3000K	B All Black	2 Gen 2
E812L Drop Glass	16 1600 lm	35 3500K	C All Chrome	
E818L Adjustable	20 2000lm	40 4000K	H All Haze	
	30 3000lm	SD Sunset Dimming	HW Haze w/White Ring	
	40 4000lm			
	60 6000lm			



ELCO Lighting

Dimmer Compatibility Chart 120/277V - 0-10V/Triac/ELV Dimmers

For 8" Laurel™ System Architectural Frames

E8LHU08D2, E8LHU12D2, E8LHU16D2, E8LHU20D2, E8LHU30D2, E8LHU40D2, E8LHU60D2, E8LFU08D2, E8LFU12D2, E8LFU16D2, E8LFU20D2, E8LFU30D2, E8LFU40D2, E8LFU60D2, E8LRU08D2, E8LRU12D2, E8LRU16D2, E8LRU20D2, E8LRU30D2, E8LRU40D2, E8LRU60D2, E8LTU08D2, E8LTU12D2, E8LTU16D2, E8LTU20D2, E8LTU30D2, E8LTU40D2, E8LTU60D2

For Reference Only

Testing conducted by ELCO Lighting is not a substitute for and does not imply certification by an independent laboratory or any other standards certification. Refer to manufacturer specifications for more detailed information on product certifications and standards. Consult the dimmer manufacturer prior to installation to ensure compatibility. **The listed values were measured under ideal conditions in a test lab. Results in the field may differ.**

Manufacturer	Product	Part Number	Dimmed Light Output Range
Triac/ELV Type Dimmers - 120V Only			
Lutron	120V AC, 150W LED/CFL or 600W Incandescent/Halogen, Single Pole, 3-Way	RRD-6CL	1% - 100%
	120V AC 60Hz, 150W LED/CFL/Incandescent/Halogen, Single Pole, 3-Way,	DVCL-153P	1% - 100%
	120V 60Hz, 150W LED/CFL or 600W Incandescent/Halogen, Single Pole, 3-Way	TGCL-153P	1% - 100%
	120V AC 60Hz, 300W Electronic Low Voltage, 3-Way, Commercial/Residential Application	DVELV-303P	1% - 100%
	120V, 600W Incandescent/Halogen, Single Pole, Residential Indoor Application	TG-600P	1% - 100%
	120V, 1000W Incandescent or 600W Magnetic Low Voltage, Single Pole, 3-Way	CT103P	1% - 100%
	120V AC 60Hz, 600W Electronic Low Voltage, Single Pole/Multi-Location,	MAELV600	1% - 100%
	120V AC 60Hz, 500W Electronic Low Voltage, Single Pole/Multi-Location,	FAELV500	1% - 100%
	120V AC 60Hz, 600W Incandescent/Halogen, Single Pole, Slide-to-Off Dimmer	S-600P	1% - 100%
	120V AC 60Hz, 150W LED/CFL or 600W Incandescent/Halogen, Single Pole, 3-Way	SCL-153P	1% - 100%
	Caséta® Wireless Dimmer	PD-6WCL	1% - 100%
	120V AC 60Hz, Low Voltage Load Type, 150W Single Pole	DVLV-600P	5% - 100%
	120V AC, 60Hz, 600W Incandescent/Halogen, Single Pole, 3-Way, Residential and Commercial Application	DV-603P	1% - 100%
	120V AC, 50/60Hz, 150W LED/CFL, 600W Incandescent/Halogen, Single Pole, 3-Way, Indoor Application	MA-PRO	1% - 100%
120V AC 60Hz, 150W LED/CFL or 600W Incandescent/Halogen, Single Pole, 3-Way,	MACL-153M	1% - 100%	
Leviton	120V AC 60Hz, 300W Electronic Low Voltage, 400 Volt Amp, Single Pole, 3-Way,	IPE04	1% - 100%
	120V AC 60Hz, 300W CFL or 600W Incandescent, 400 Volt Amp, Single Pole, 3-Way,	6673-10W	1% - 100%
	120V AC, 600W Incandescent with LED Locator, Single Pole, 3-Way	VP106	1% - 100%
	120V AC 60Hz, 500W Incandescent with LED Level Indicator, Single Pole, 3-Way	6161	1% - 100%
	120V AC, 150W LED/CFL or 600W Incandescent, Single Pole, 3-Way	6674	1% - 100%
Eaton	120V AC, 300W LED/CFL or 600W Incandescent/MLV/Halogen, Single Pole, 3-Way	TAL06P1-C1	1% - 100%
Cooper	120V AC 60Hz, 300W LED/CFL or 600W Incandescent/Halogen, Single Pole, 3-Way	SLC03P / DAL06P	1% - 100%
	120V AC 60Hz, 300W LED/CFL or 600W Incandescent, Single Pole, 3-Way, Residential	DLC03P	1% - 100%
	120V AC 60Hz, 600W Incandescent/Halogen, Single Pole, 3-Way,	RI061-VW-K2	1% - 100%
	120V AC 60Hz, 300W LED/CFL/ Incandescent/Halogen, Single Pole, 3-Way	AAL06A-C2	1% - 100%
Lightolier	120V, 260W Incandescent/Halogen, Single Pole, 3-Way,	ZP260QEW	1% - 100%

Integrating our lighting with your Smart Home System is a breeze. Simply check your Smart Home system for compatible smart switches and cross reference that with our Dimming Compatibility Chart. Once the switches are integrated with your Smart Home system your lights will be ready to go.



2042 E. Vernon Ave. Vernon CA 90058 Tel 323.231.2600 Fax 323.231.3200 elcolighting.com

RV 07.24

Manufacturer	Product	Part Number	Dimmed Light Output Range
0-10V Type Dimmers - 120/277V			
Lutron	120/277V AC, 0-10V LED/CFL Ballast, Single Pole, 3-Way	NFTV	1% - 100%
	120/277V AC, 0-10V, Single Pole, 3-Way, Commercial and Residential, Indoor Application	DVSTV	1% - 100%
	120/277V AC 50/60Hz, 0-10V LED/CFL Ballast, Single Pole, 3-Way, Indoor Application	DVTV	1% - 100%
Leviton	120/277V AC 60Hz, 0-10V LED/CFL Ballast, Single Pole, 3-Way	IP710-DL	1% - 100%

***NOTE: Refer to dimmer manufacturer’s documentation for installation instructions and circuit details**

Disclaimer: Minimum and maximum loads for LEDs and CFLs are given in number of lamps and may vary depending on the lamp being used. Testing conducted by ELCO Lighting is not a substitute for and does not imply certification by an independent laboratory or any other standards certification. Refer to manufacturer specifications for more detailed information on product certifications and standards.

Integrating our lighting with your Smart Home System is a breeze. Simply check your Smart Home system for compatible smart switches and cross reference that with our Dimming Compatibility Chart. Once the switches are integrated with your Smart Home system your lights will be ready to go.

