

6" Super Sloped Ceiling LED Baffle Inserts

Sloped Ceiling LED inserts feature an integral gimbal for $\pm 25^\circ$ adjustability. Compatible with most incandescent and electronic low voltage dimmers.



Features

- Sloped Ceiling LED Inserts feature an integral gimbal for $\pm 25^\circ$ adjustability.
- Compatible with most incandescent and electronic low voltage dimmers.
- ENERGY STAR® Certified. California Title 24 (JA8-2016-E).
- Life Span: 50,000 hours L70.

Specifications

Wattage	15W
Lumens	1200 lm
Voltage	120V
Color Temp.	3000K
Dimmable	Triac/ELV
Lamp Type	LED
CRI	90+
Damp Location	Listed

Options



White

Black w/White Trim

Bronze

Technical Details

Optics: LED light engine has frosted polycarbonate lens with reflector to diffuse light evenly while reducing glare.

Construction: Deep baffle trim with torsion springs to be held into the housing. High quality powder coat finish preventing rust and paint cracking on metal parts. Integral gimbal allows for 25° adjustability to match slope.

Installation: Designed to install into ELCO 6" Super Sloped ceiling housing with torsion springs brackets. For retrofitting other manufacturers sloped ceiling cans always test the product to ensure proper fit and function.

Electrical:

- Driver connects to 120VAC power supply.
- High efficiency, high power factor > 0.9 driver.

LED Technology:

- Accurate color rendering with 90+ CRI.
- Lumen Maintenance of 50,000 hours L70 Life based on LM80 standardized test results.
- Superior Thermal Management by utilizing aluminum diecast heat sink.

Housings: Compatible with EL971ICA, EL971RICA.

Dimmability:

- Dimmable with most standard TRIAC and ELV type dimmers.
- Dimming range of 100% down to 10%. Dimming range may vary depending on dimmer model.
- For full list of dimmers refer to the Dimmer Compatibility List.

Listings:

- UL Listed for Damp Location.
- ENERGY STAR® Certified.

Dimensions

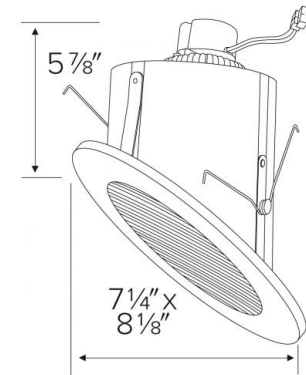

Product Number

Item	Lamp type	Lumens	CCT	Watts	Voltage	Dimming	Finish
EL76430BZ	LED	1200 lm	3000K	15W	120V	Triac/ELV	All Bronze

- California Title 24 (JA8-2016-E).

Warranty: ELCO Products are built to last. 5-year Limited warranty.

Product Number Builder Example: EL76327B

ELCO 6" Baffle Insert

Wattage

Color Temp.

Finish

EL76

3 15W

4 18W

27 2700K

30 3000K

CT5 2700K - 5000K

W All White

B Black with White Trim

BZ All Bronze

For use with 6" LED Super Sloped Inserts

6" Dedicated LED Super Sloped Ceiling IC Housings

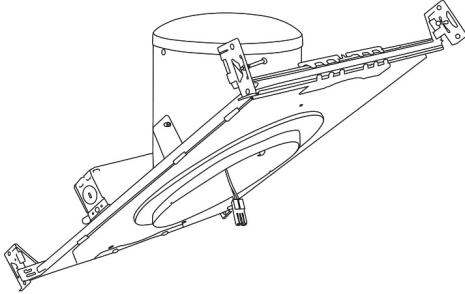

6" LED Sloped Housing
New Construction

CAT NO.	SPECIFICATIONS
EL971ICA	24W Max.

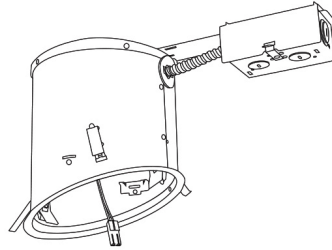

6" LED Sloped Housing
Remodel

CAT NO.	SPECIFICATIONS
EL971RICA	24W Max.

6" E26 Base Super Sloped Ceiling Housings

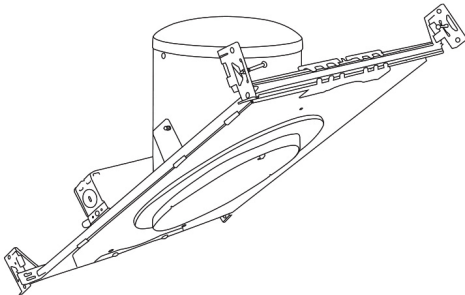

6" E26 Medium Base Sloped Housing
New Construction

CAT NO.	SPECIFICATIONS
EL901ICA	75W Max.

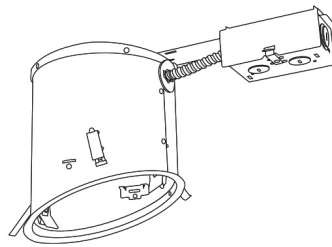

6" E26 Medium Base Sloped Housing
Remodel

CAT NO.	SPECIFICATIONS
EL901RICA	75W Max.

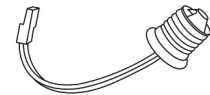

PSA30
Medium base to Ideal terminal connector

Super Sloped Ceiling LED Baffle Insert

Multiplier: 2700K (x 0.96)

PHOTOMETRIC REPORT

Product #: EL76430
 Wattage/Lumens: 17.1W/ 1191 Lm
 Luminaire LPW: 70 Lm/W

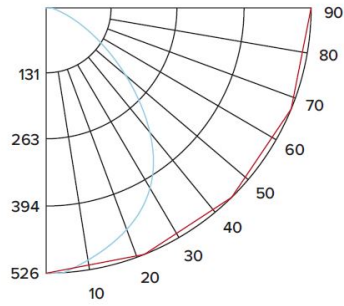

CANDLE POWER SUMMARY

Degrees Vertical	0°
0	524
5	523
15	501
25	456
35	384
45	265
55	129
65	63
75	41
85	7
90	0

ILLUMINANCE AT A DISTANCE

Distance to Target Plane	Footcandles Beam Center	Beam Diameter
4'	32.7	7.9'
6'	14.5	11.8'
8'	8.18	15.8'
10'	5.24	19.7'

ZONAL LUMEN SUMMARY

Zone	Lumens	% Luminaire
0-30°	398.39	33.50
0-40°	639.58	53.70
0-60°	1037.74	87.10
0-90°	1188.04	99.80



ELCO Lighting

Dimmer Compatibility Chart

6" Super Sloped Ceiling LED Inserts

For EL761, EL762, EL763, and EL764 Series

For Reference Only

Testing conducted by ELCO Lighting is not a substitute for and does not imply certification by an independent laboratory or any other standards certification. Refer to manufacturer specifications for more detailed information on product certifications and standards. Consult the dimmer manufacturer prior to installation to ensure compatibility.

Manufacturer	Product	Part Number	Dimmed Light Output Range
Lutron	Skylark Contour, 120V AC, 60Hz, 600W Incandescent/Halogen, Single Pole, 3-Way Indoor Application, Residential/Commercial Application	CT-603PG / CT-600PR	10% - 100%
	Diva, 120V AC, 60Hz, 600W Incandescent/Halogen, Single Pole, 3-Way, Residential/Commercial Application	DV-600PR / DV603PG	10% - 100%
	Diva, 120V, 60Hz, 150W LED/CFL, 600W Incandescent/Halogen, Single Pole, 3-Way	DVW-603PGH / DVCL-153P	10% - 100%
	Maestro, 120V, 50/60Hz, 150W LED/CFL, 600W Incandescent/Halogen, Single Pole, 3-Way	MACL-153M / TGCL-153P	10% - 100%
	Skylark, Single Pole 600W Incandescent/Halogen, Slide-to-Off Dimmer	S-600PR / S-2-LH	10% - 100%
Leviton		1A1505 / IC1605	10% - 100%
	SureSlide, 120V AC 60Hz, 600W for LED and CFL, 600W for Incandescent, Single Pole, 3-Way, Polycarbonated Housing	6631 / 6633	10% - 100%
Cooper	Decorator Dimmer, 120V 60Hz, 300W for LED and CFL, 600W for Incandescent, Single Pole, 3-Way, Polycarbonated Housing	DLC03P	10% - 100%

***NOTE: Refer to dimmer manufacturer's documentation for installation instructions and circuit details**

Disclaimer: Minimum and maximum loads for LEDs and CFLs are given in number of lamps and may vary depending on the lamp being used. Testing conducted by ELCO Lighting is not a substitute for and does not imply certification by an independent laboratory or any other standards certification. Refer to manufacturer specifications for more detailed information on product certifications and standards.

Integrating our lighting with your Smart Home System is a breeze. Simply check your Smart Home system for compatible smart switches and cross reference that with our Dimming Compatibility Chart. Once the switches are integrated with your Smart Home system your lights will be ready to go.



2042 E. Vernon Ave. Vernon CA 90058 Tel 323.231.2600 Fax 323.231.3200 elcolighting.com