

6" LED Light Engine with Drop Glass Trim

The perfect lighting solution for high-end residential and light commercial projects.



Features

- High efficacy LED module.
- Triac/ELV/0-10V dimming.
- Life span of 50,000 hours L70.
- USA designed and assembled.
- Limited 5 year warranty.
- 2 at the end of the item number denotes Generation 2.
Please note Gen 2 and Gen 1 are not cross compatible.

Specifications

Wattage	18W
Lumens	1600 lm
Color Temp.	4000K
Lamp Type	LED
Beam Angle	60°
CRI	93+
Damp Location	Listed

Options



All White



Haze w/White Trim



Gold w/White Trim



Chrome w/White Trim



All Bronze



Black w/White Trim

Technical Details

Optics: Frosted polycarbonate module lens diffuses light evenly throughout while reducing glare with LED technology.

Trim Construction: Reflector is two piece trim for maximum color versatility. Design allows for minimal glare and a strong glare cut-off. Trim is constructed of metal for lasting durability.

Installation: Must be installed on a Cedar™ System frame with compatible lumen rating. Frames are available for New Construction and Remodel as IC or non-IC.

LED Technology: Extremely accurate Color Rendering Index of 93+. Efficacy of 97 lumens per watt. Lumen Maintenance of 50,000 hours L70 Life based on LM80 standardized test results. Superior Thermal Management by utilizing ELCO Red heat sink. Instant On to Full Brightness technology. No LED pixelation.

Sunset: Sunset color temperature is our dim-to-warm LED technology that allows the color temperature to become warmer as the product is dimmed. Our SUNSET items start at 3000K and go as low as 1800K when dimmed. For Sunset dim technology be sure to order an item with "Sunset" in the Color Temperature (CCT) attribute.

Listings: cUL Listed, Wet Location. RoHS Compliant. California Title 24 (JA8-2016-E).

Dimensions



Product Number Builder Example: E612C0827W2

ELCO 6" Drop Glass

Lumens

Color Temp.

Finish

Generation

Beam Angle

E612C					
	08 850 lm	27 2700K	W All White	2 Gen 2	60° lens
	12 1250 lm	30 3000K	BZ All Bronze	1 Gen 1	-F 38° lens
	16 1600 lm	35 3500K	B Black with White Trim		-N 24° lens
	20 2000 lm	40 4000K	C Chrome with White Trim		-S 15° lens
		50 5000K	H Haze with White Trim		
		SD Sunset ¹	G Gold with White Trim		

¹ Sunset, Dim to Warm technology, automatically transitions from 3000K to 1800K when dimmed

LED Light Engine

Multiplier: 2700K (x 0.96), 3500K (x 1.04), 4000K (x 1.08)

PHOTOMETRIC REPORT

Product #: E612C1230
 Wattage/Lumens: 15.7W/ 1076 Lm
 Luminaire LPW: 69 Lm/W



CANDLE POWER SUMMARY

Degrees Vertical	Candle Power
0°	1715
5°	1614
15°	1099
25°	864
35°	322
45°	24
55°	1
65°	1
75°	0
85°	0
90°	0

ILLUMINANCE AT A DISTANCE

Distance to Target Plane	Footcandles Beam Center	Beam Diameter
4'	107	3.8'
6'	47.6	5.6'
8'	26.8	7.5'
10'	17.1	9.4'

ZONAL LUMEN SUMMARY

Zone	Lumens	% Luminaire
0-30°	839.73	78.00
0-40°	1048.35	97.40
0-60°	1075.43	99.90
0-90°	1076.31	100.00

LED Light Engine

Multiplier: 2700K (x 0.96), 3500 (x 1.04), 4000K (x 1.08)

PHOTOMETRIC REPORT

Product #: E612C2030
 Wattage/Lumens: 21.6W/ 1751 Lm
 Luminaire LPW: 81 Lm/W

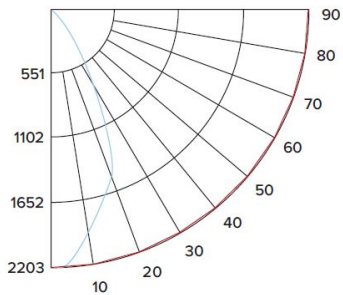

CANDLE POWER SUMMARY

Degrees Vertical	Candle Power
0°	2203
5°	2155
15°	1746
25°	1401
35°	597
45°	55
55°	2
65°	1
75°	0
85°	0
90°	0

ILLUMINANCE AT A DISTANCE

Distance to Target Plane	Footcandles Beam Center	Beam Diameter
4'	138	4.5'
6'	61.2	6.8'
8'	34.4	9.1'
10'	22.0	11.3'

ZONAL LUMEN SUMMARY

Zone	Lumens	% Luminaire
0-30°	1313.28	75.00
0-40°	1689.32	96.50
0-60°	1749.93	99.90
0-90°	1751.25	100.00

Compatible Products

For use with 6" Cedar™ Light Engines

6" Cedar™ Dedicated LED ICA Housings



2-Hour Fire Rated
6" ICA Housing
New Construction



6" ICA Housing
New Construction



6" ICA Housing
New Construction



6" ICA Housing
Remodel

CAT NO.	SPECIFICATIONS	CAT NO.	SPECIFICATIONS	CAT NO.	SPECIFICATIONS	CAT NO.	SPECIFICATIONS
E6FH	Up to 1250lm	E6LC	Up to 2000lm	E6LC	Up to 1250lm	E6LRC	Up to 1250lm

6" Cedar™ Dedicated LED Non-IC Housings



6" Non-IC Housing
New Construction



6" Non-IC Housing
Remodel

CAT NO.	SPECIFICATIONS	CAT NO.	SPECIFICATIONS
E6LC	Up to 2000lm	E6LRC	Up to 2000lm

PRODUCT NUMBER BUILDER

Housing Type	Lumen	ICA Airtight	Dimming	Optional
<input type="text"/>	<input type="text"/>	<input type="text"/>	<input type="text"/>	<input type="text"/>
E6FH Fire Rated	08 850 lm	(Blank) Non-IC	(Blank) 120V Triac/ELV	EM1 Emergency Backup up to 700 lm output
E6LC New Construction	12 1250 lm	ICA IC Airtight	D 120/277V Triac/ELV/0-10V	EM2 Emergency Backup up to 1100 lm output
E6LRC Remodel	16 1600 lm		L Lutron	
	20 2000 lm			