

# 6" LED Light Engine with Drop Glass Trim

The perfect lighting solution for high-end residential and light commercial projects.



## Features

- High efficacy LED module.
- Triac/ELV/0-10V dimming.
- Life span of 50,000 hours L70.
- USA designed and assembled.
- Limited 5 year warranty.
- 2 at the end of the item number denotes Generation 2.  
Please note Gen 2 and Gen 1 are not cross compatible.

## Specifications

<b>Wattage</b>	8.76W
<b>Lumens</b>	850 lm
<b>Color Temp.</b>	4000K
<b>Lamp Type</b>	LED
<b>Beam Angle</b>	60°
<b>CRI</b>	93+
<b>Damp Location</b>	Listed

## Options



All White



Haze w/White Trim



Gold w/White Trim



Chrome w/White Trim



All Bronze



Black w/White Trim

## Technical Details

**Optics:** Frosted polycarbonate module lens diffuses light evenly throughout while reducing glare with LED technology.

**Trim Construction:** Reflector is two piece trim for maximum color versatility. Design allows for minimal glare and a strong glare cut-off. Trim is constructed of metal for lasting durability.

**Installation:** Must be installed on a Cedar™ System frame with compatible lumen rating. Frames are available for New Construction and Remodel as IC or non-IC.

**LED Technology:** Extremely accurate Color Rendering Index of 93+. Efficacy of 97 lumens per watt. Lumen Maintenance of 50,000 hours L70 Life based on LM80 standardized test results. Superior Thermal Management by utilizing ELCO Red heat sink. Instant On to Full Brightness technology. No LED pixelation.

**Sunset:** Sunset color temperature is our dim-to-warm LED technology that allows the color temperature to become warmer as the product is dimmed. Our SUNSET items start at 3000K and go as low as 1800K when dimmed. For Sunset dim technology be sure to order an item with "Sunset" in the Color Temperature (CCT) attribute.

**Listings:** cUL Listed, Wet Location. RoHS Compliant. California Title 24 (JA8-2016-E).

## Dimensions

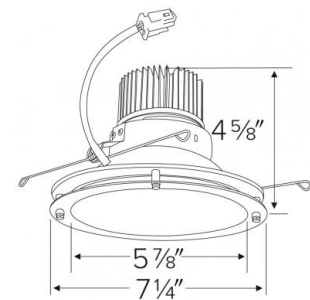

# Product Number Builder Example: E612C0827W2

ELCO 6" Drop Glass

Lumens

Color Temp.

Finish

Generation

Beam Angle

<b>E612C</b>					
	<b>08</b> 850 lm	<b>27</b> 2700K	<b>W</b> All White	<b>2</b> Gen 2	60° lens
	<b>12</b> 1250 lm	<b>30</b> 3000K	<b>BZ</b> All Bronze	<b>1</b> Gen 1	<b>-F</b> 38° lens
	<b>16</b> 1600 lm	<b>35</b> 3500K	<b>B</b> Black with White Trim		<b>-N</b> 24° lens
	<b>20</b> 2000 lm	<b>40</b> 4000K	<b>C</b> Chrome with White Trim		<b>-S</b> 15° lens
		<b>50</b> 5000K	<b>H</b> Haze with White Trim		
		<b>SD</b> Sunset <sup>1</sup>	<b>G</b> Gold with White Trim		

<sup>1</sup> Sunset, Dim to Warm technology, automatically transitions from 3000K to 1800K when dimmed

## LED Light Engine

Multiplier: 2700K (x 0.96), 3500K (x 1.04), 4000K (x 1.08)

### PHOTOMETRIC REPORT

Product #: E612C1230  
 Wattage/Lumens: 15.7W/ 1076 Lm  
 Luminaire LPW: 69 Lm/W



### CANDLE POWER SUMMARY

Degrees Vertical	Candle Power
0°	1715
5°	1614
15°	1099
25°	864
35°	322
45°	24
55°	1
65°	1
75°	0
85°	0
90°	0

### ILLUMINANCE AT A DISTANCE

Distance to Target Plane	Footcandles Beam Center	Beam Diameter
4'	107	3.8'
6'	47.6	5.6'
8'	26.8	7.5'
10'	17.1	9.4'

### ZONAL LUMEN SUMMARY

Zone	Lumens	% Luminaire
0-30°	839.73	78.00
0-40°	1048.35	97.40
0-60°	1075.43	99.90
0-90°	1076.31	100.00

## LED Light Engine

Multiplier: 2700K (x 0.96), 3500 (x 1.04), 4000K (x 1.08)

### PHOTOMETRIC REPORT

Product #: E612C2030  
 Wattage/Lumens: 21.6W/ 1751 Lm  
 Luminaire LPW: 81 Lm/W



### CANDLE POWER SUMMARY

Degrees Vertical	Candle Power
0°	2203
5°	2155
15°	1746
25°	1401
35°	597
45°	55
55°	2
65°	1
75°	0
85°	0
90°	0

### ILLUMINANCE AT A DISTANCE

Distance to Target Plane	Footcandles Beam Center	Beam Diameter
4'	138	4.5'
6'	61.2	6.8'
8'	34.4	9.1'
10'	22.0	11.3'

### ZONAL LUMEN SUMMARY

Zone	Lumens	% Luminaire
0-30°	1313.28	75.00
0-40°	1689.32	96.50
0-60°	1749.93	99.90
0-90°	1751.25	100.00

# Compatible Products

For use with 6" Cedar™ Light Engines

## 6" Cedar™ Dedicated LED ICA Housings



2-Hour Fire Rated  
6" ICA Housing  
**New Construction**



6" ICA Housing  
**New Construction**



6" ICA Housing  
**New Construction**



6" ICA Housing  
**Remodel**

CAT NO.	SPECIFICATIONS	CAT NO.	SPECIFICATIONS	CAT NO.	SPECIFICATIONS	CAT NO.	SPECIFICATIONS
E6FH	Up to 1250lm	E6LC	Up to 2000lm	E6LC	Up to 1250lm	E6LRC	Up to 1250lm

## 6" Cedar™ Dedicated LED Non-IC Housings



6" Non-IC Housing  
**New Construction**



6" Non-IC Housing  
**Remodel**

CAT NO.	SPECIFICATIONS	CAT NO.	SPECIFICATIONS
E6LC	Up to 2000lm	E6LRC	Up to 2000lm

### PRODUCT NUMBER BUILDER

Housing Type	Lumen	ICA Airtight	Dimming	Optional
<input type="text"/>	<input type="text"/>	<input type="text"/>	<input type="text"/>	<input type="text"/>
<b>E6FH</b> Fire Rated	<b>08</b> 850 lm	<b>(Blank)</b> Non-IC	<b>(Blank)</b> 120V Triac/ELV	<b>EM1</b> Emergency Backup up to 700 lm output
<b>E6LC</b> New Construction	<b>12</b> 1250 lm	<b>ICA</b> IC Airtight	<b>D</b> 120/277V Triac/ELV/0-10V	<b>EM2</b> Emergency Backup up to 1100 lm output
<b>E6LRC</b> Remodel	<b>16</b> 1600 lm		<b>L</b> Lutron	
	<b>20</b> 2000 lm			