

# 6" Drop Glass Reflector

The perfect lighting solution for high-end residential projects with existing housings.



## Features

- Module includes LED Module Driver.
- Frosted acrylic lens for even lumen distribution.
- USA designed and assembled
- Title 24 JA8-2019 Compliant
- Life span of 50,000 hours L70
- Limited 5 year warranty

## Specifications

<b>Wattage</b>	11.4W
<b>Lumens</b>	850 lm
<b>Voltage</b>	120V
<b>Color Temp.</b>	2700K
<b>Dimmable</b>	Triac/ELV
<b>Lamp Type</b>	LED
<b>Beam Angle</b>	60°
<b>CRI</b>	93+
<b>Wet Location</b>	Listed

## Options



All White



Black w/White Ring



All Bronze



Chrome w/White Ring



Gold w/White Ring



Haze w/White Ring

## Technical Details

**Optics:** Frosted polycarbonate module lens diffuses light evenly throughout while reducing glare with LED technology.

**Trim Construction:** Reflector is two piece trim for maximum color versatility. Design allows for minimal glare and a strong glare cut-off. Trim is constructed of metal for lasting durability.

### LED Technology:

- Extremely accurate Color Rendering Index of 93+.
- Efficacy of 97 lumens per watt.
- Lumen Maintenance of 50,000 hours L70 Life based on LM80 standardized test results.
- Superior Thermal Management by utilizing ELCO Red heat sink.
- Instant On to Full Brightness technology.
- No LED pixilation.

**Sunset:** Sunset color temperature is our dim-to-warm LED technology that allows the color temperature to become warmer as the product is dimmed. Our SUNSET items start at 3000K and go as low as 1800K when dimmed. For Sunset dim technology be sure to order an item with "Sunset" in the Color Temperature (CCT) attribute.

**Listings:** cUL Listed for Wet Location. RoHS Compliant. Title 24 JA8-2019 Compliant.

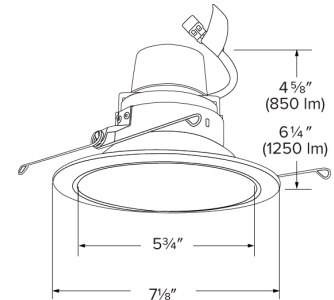

# Product Number Builder

Example: **E612R0827W**

ELCO 4" Drop Glass	Lumens	Color Temp	Finish	Beam Angle
<b>E612R</b>				
	<b>08</b> 850 lm <b>12</b> 1250 lm	<b>27</b> 2700K <b>30</b> 3000K <b>35</b> 3500K <b>40</b> 4000K <b>50</b> 5000K <b>SD</b> Sunset <sup>1</sup>	<b>W</b> All White <b>B</b> Black with White Ring <b>BZ</b> All Bronze <b>C</b> Chrome with White Trim <b>G</b> Gold with White Trim <b>H</b> Haze with White Trim	60° lens <b>-F</b> 38° lens <b>-N</b> 24° lens <b>-S</b> 15° lens

<sup>1</sup> Sunset, Dim to Warm technology, automatically transitions from 3000K to 1800K when dimmed

# Compatible Products

For use with 6" Cedar™ LED Module & Driver



## 6" Dedicated LED ICA Housings



6" IC Housing  
New Construction

CAT NO.	SPECIFICATIONS
EL770ICA	24W MAX.



6" ICA Housing  
Remodel

CAT NO.	SPECIFICATIONS
EL770RICA	24W MAX.

## 6" Accessories



Emergency Battery Backup

CAT NO.	SPECIFICATIONS
KEM-LD5	8W, 120/277V



Fire Enclosure

CAT NO.	SPECIFICATIONS
FIREENCL	20 3/8" L x 14 3/8" W
FIREENCL-S	Shallow, 16" L x 14 3/8" W



Mica Fire Tape

CAT NO.	SPECIFICATIONS
FIRETAPE	3/4" W x 16' L



Automatic Daylight Control Sensor

CAT NO.	SPECIFICATIONS
EADC1	For use with 0-10V frames.



Socket Adapter

CAT NO.	SPECIFICATIONS
PSA30	E26 to Quick Connect



**ELCO Lighting**

# Dimmer Compatibility Chart LED Module & Driver

## For Reference Only

Testing conducted by ELCO Lighting is not a substitute for and does not imply certification by an independent laboratory or any other standards certification. Refer to manufacturer specifications for more detailed information on product certifications and standards. Consult the dimmer manufacturer prior to installation to ensure compatibility.

Manufacturer	Product	Part Number	Dimmed Light Output Range
<b>Triac/ELV</b>			
Cooper	ASPIRE Decorator Single Pole/3-Way Dimmer	9573WS	10% - 100%
	DEVINE Decorator Dimmer	DI06P-A-K	10% - 100%
Legrand	Adorne® Paddle 450W Single Pole/3-Way Dimmer	ADPD453L-W2	10% - 100%
Leviton	Illumatech Single Pole/3-Way Incandescent Dimmer	IPI06	10% - 100%
	Decora Sureslide Single Pole Slide-to-Off Incandescent Dimmer	6631-LW	10% - 100%
	Decora Sureslide Single Pole/3-Way Magnetic Low Voltage Dimmer	6613-PL	8% - 100%
Lutron	Skylark® Single Pole/3-Way Incandescent/Halogen "Eco-Dim" Dimmer	S-603PG	5% - 85%
	Diva® C•L Single Pole/3-Way Dimmer	DVCL-153PR	7%-100%
	Ariadni Single Pole/3-Way Dimmer	AY-600P-AL	10% - 100%
	Maestro® Incandescent/Halogen Digital Fade Dimmer	MRF2-600M-WH	10% - 100%
	Skylark® Single Pole/3-Way Incandescent/Halogen Dimmer	S-600P-AL	10% - 100%
	Diva® Single Pole Incandescent/Halogen Dimmer	DV-600P-WH	10% - 100%
	Nova® Single Pole Incandescent/Halogen Slide-to-Off Dimmer	N-600	10% - 100%
	Skylark® Single Pole Magnetic Low Voltage Dimmer	SLV-600-WH	8% - 100%
Glyder® Single Pole Magnetic Low Voltage Dimmer	GLV-600-WH	8% - 100%	

\*NOTE: Refer to dimmer manufacturer's documentation for installation instructions and circuit details

Disclaimer: Minimum and maximum loads for LEDs and CFLs are given in number of lamps and may vary depending on the lamp being used. Testing conducted by ELCO Lighting is not a substitute for and does not imply certification by an independent laboratory or any other standards certification. Refer to manufacturer specifications for more detailed information on product certifications and standards.