

6" Drop Glass Reflector

The perfect lighting solution for high-end residential projects with existing housings.



Features

- Module includes LED Module Driver.
- Frosted acrylic lens for even lumen distribution.
- USA designed and assembled
- Title 24 JA8-2019 Compliant
- Life span of 50,000 hours L70
- Limited 5 year warranty

Specifications

| | |
|---------------------|-----------|
| Wattage | 11.4W |
| Lumens | 850 lm |
| Voltage | 120V |
| Color Temp. | 2700K |
| Dimmable | Triac/ELV |
| Lamp Type | LED |
| Beam Angle | 60° |
| CRI | 93+ |
| Wet Location | Listed |

Options



All White



Black w/White Ring



All Bronze



Chrome w/White Ring



Gold w/White Ring



Haze w/White Ring

Technical Details

Optics: Frosted polycarbonate module lens diffuses light evenly throughout while reducing glare with LED technology.

Trim Construction: Reflector is two piece trim for maximum color versatility. Design allows for minimal glare and a strong glare cut-off. Trim is constructed of metal for lasting durability.

LED Technology:

- Extremely accurate Color Rendering Index of 93+.
- Efficacy of 97 lumens per watt.
- Lumen Maintenance of 50,000 hours L70 Life based on LM80 standardized test results.
- Superior Thermal Management by utilizing ELCO Red heat sink.
- Instant On to Full Brightness technology.
- No LED pixilation.

Sunset: Sunset color temperature is our dim-to-warm LED technology that allows the color temperature to become warmer as the product is dimmed. Our SUNSET items start at 3000K and go as low as 1800K when dimmed. For Sunset dim technology be sure to order an item with "Sunset" in the Color Temperature (CCT) attribute.

Listings: cUL Listed for Wet Location. RoHS Compliant. Title 24 JA8-2019 Compliant.

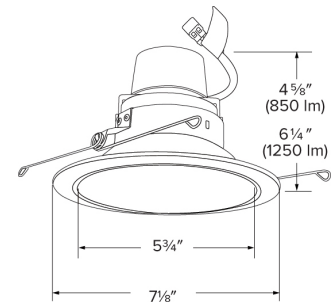

Product Number Builder

Example: **E612R0827W**

| ELCO 4" Drop Glass | Lumens | Color Temp | Finish | Beam Angle |
|--------------------|---------------------------------------|--|---|--|
| E612R | | | | |
| | 08 850 lm 12 1250 lm | 27 2700K 30 3000K 35 3500K 40 4000K 50 5000K SD Sunset ¹ | W All White B Black with White Ring BZ All Bronze C Chrome with White Trim G Gold with White Trim H Haze with White Trim | 60° lens -F 38° lens -N 24° lens -S 15° lens |

¹ Sunset, Dim to Warm technology, automatically transitions from 3000K to 1800K when dimmed

Compatible Products

For use with 6" Cedar™ LED Module & Driver



6" Dedicated LED ICA Housings



6" IC Housing
New Construction

| CAT NO. | SPECIFICATIONS |
|----------|----------------|
| EL770ICA | 24W MAX. |



6" ICA Housing
Remodel

| CAT NO. | SPECIFICATIONS |
|-----------|----------------|
| EL770RICA | 24W MAX. |

6" Accessories



Emergency Battery Backup

| CAT NO. | SPECIFICATIONS |
|---------|----------------|
| KEM-LD5 | 8W, 120/277V |



Fire Enclosure

| CAT NO. | SPECIFICATIONS |
|------------|----------------------------|
| FIREENCL | 20 3/8" L x 14 3/8" W |
| FIREENCL-S | Shallow, 16" L x 14 3/8" W |



Mica Fire Tape

| CAT NO. | SPECIFICATIONS |
|----------|----------------|
| FIRETAPE | 3/4" W x 16' L |



Automatic Daylight Control Sensor

| CAT NO. | SPECIFICATIONS |
|---------|----------------------------|
| EADC1 | For use with 0-10V frames. |



Socket Adapter

| CAT NO. | SPECIFICATIONS |
|---------|----------------------|
| PSA30 | E26 to Quick Connect |



ELCO Lighting

Dimmer Compatibility Chart LED Module & Driver

For Reference Only

Testing conducted by ELCO Lighting is not a substitute for and does not imply certification by an independent laboratory or any other standards certification. Refer to manufacturer specifications for more detailed information on product certifications and standards. Consult the dimmer manufacturer prior to installation to ensure compatibility.

| Manufacturer | Product | Part Number | Dimmed Light Output Range |
|---|--|--------------|---------------------------|
| Triac/ELV | | | |
| Cooper | ASPIRE Decorator Single Pole/3-Way Dimmer | 9573WS | 10% - 100% |
| | DEVINE Decorator Dimmer | DI06P-A-K | 10% - 100% |
| Legrand | Adorne® Paddle 450W Single Pole/3-Way Dimmer | ADPD453L-W2 | 10% - 100% |
| Leviton | Illumatech Single Pole/3-Way Incandescent Dimmer | IPI06 | 10% - 100% |
| | Decora Sureslide Single Pole Slide-to-Off Incandescent Dimmer | 6631-LW | 10% - 100% |
| | Decora Sureslide Single Pole/3-Way Magnetic Low Voltage Dimmer | 6613-PL | 8% - 100% |
| Lutron | Skylark® Single Pole/3-Way Incandescent/Halogen "Eco-Dim" Dimmer | S-603PG | 5% - 85% |
| | Diva® C•L Single Pole/3-Way Dimmer | DVCL-153PR | 7%-100% |
| | Ariadni Single Pole/3-Way Dimmer | AY-600P-AL | 10% - 100% |
| | Maestro® Incandescent/Halogen Digital Fade Dimmer | MRF2-600M-WH | 10% - 100% |
| | Skylark® Single Pole/3-Way Incandescent/Halogen Dimmer | S-600P-AL | 10% - 100% |
| | Diva® Single Pole Incandescent/Halogen Dimmer | DV-600P-WH | 10% - 100% |
| | Nova® Single Pole Incandescent/Halogen Slide-to-Off Dimmer | N-600 | 10% - 100% |
| | Skylark® Single Pole Magnetic Low Voltage Dimmer | SLV-600-WH | 8% - 100% |
| Glyder® Single Pole Magnetic Low Voltage Dimmer | GLV-600-WH | 8% - 100% | |

*NOTE: Refer to dimmer manufacturer's documentation for installation instructions and circuit details

Disclaimer: Minimum and maximum loads for LEDs and CFLs are given in number of lamps and may vary depending on the lamp being used. Testing conducted by ELCO Lighting is not a substitute for and does not imply certification by an independent laboratory or any other standards certification. Refer to manufacturer specifications for more detailed information on product certifications and standards.