

6" 0-10V LED Shallow Fire Rated ICA New Construction Housing



6" 0-10V 2-Hour fire rated new construction LED shallow housing. Compatible with 6" 0-10V LED inserts and 0-10V Koto™ Module.

Features

- 24W MAX.
- 2-Hour Fire Rated housing
- Wired for 0-10V Dimming
- IC Airtight Rated for direct contact with insulation
- 120/277V Input , 60Hz
- Meets Title 24 High Efficacy requirements
- Housing Meets Restricted Air Flow requirements (per ASTM E-283)
- cUL Listed for damp locations
- cUL Listed for wet locations
- Height: 6 3/16"

Specifications

Wattage	24W
Voltage	120/277V
Dimmable	0-10V/Triac/ELV
Damp Location Listed	

Dimensions

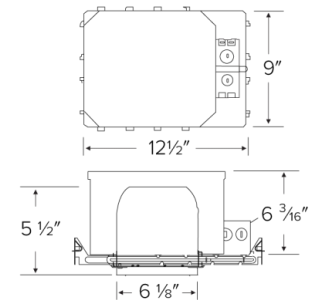

Technical Details

Construction:

- Double wall IC rated for direct contact with insulation. For use in IC and non-IC conditions.
- Housing adjusts in frame to accommodate up to 1 1/2" ceiling thickness.
- Airtight housing with gasket to restrict airflow in accordance with ASTM E-283 air-tight requirements.

Installation:

- Designed for ceiling plenums where 2x8 joists or taller are used.
- High strength hanger bars can easily be nailed to joists.
- Suitable for T-grid and drop ceiling applications.
- See installation sheet for detailed information.

Junction Box: Positioned to accommodate straight conduit runs. Two 3/4" knockouts, Seven 1/2" trade size conduit knockouts, One 3/8" knockout. Four Pry-out knockout slots for easy romex installation.

Emergency Battery Pack: Optional 90 minute battery pack available with test indicator switch. Note that double wall housings require Access From Above Ceiling for Battery Maintenance.

Hanger Bars: Pre Installed hanger bars with True Nail easy installation in regular lumber, engineered lumber, and Laminated Beams. Integral T-bar slots for easy installation in T-Bars. Spans up 24" and can be repositioned 90°. Score lines allow for tool-free hanger bar size reduction. Integral leveling flange allows for single-person installation while easily aligning the housings with the joists.

Lamp: Designed for use with ELCO 6" 0-10V LED inserts and 0-10V Koto™ Module.

Listings: cUL Listed for Damp Location and for Wet Location with select trims. cUL Listed for Direct Contact with Insulation and Combustible Material. cUL Listed for Feed Through.

Product Numbers

Item	Watts	Voltage	Dimming
EL75FICDXAS	24W	120/277V	0-10V/Triac/ELV

Compatible Products



For use with Dedicated 6" IC LED Housings

6" Ply™ 120/277V LED Inserts



Round Insert with 5-CCT and 3-Lumen Switch

EL685CT5D

Finishes:
(W, BB, CW, HW)



Round Insert

EL695

Finishes:
(DCW)

*Finishes: **W** - All White, **BB** - All Black, **H** - All Haze, **HW** - Haze w/White Ring

*Must be used with PLY™ Housings for 0-10V dimmability (EL770ICDXA, EL770RICDXA, EL76FICDXA, EL760ICDXA, EL760RICDXA).
With non-ply housing this is non-dimmable, 120-277V input only.

6" Ply™ 120/277V Adjustable LED Inserts



Round Adjustable Pull Down

EL697

Finishes:
(DXW, DXB, DXBZ)

ACCESSORIES



Interchangeable Lens
(For EL697 Series only)

EP710C 20° Beam
EP712C 60° Beam

PRODUCT NUMBER BUILDER

6" 120/277V Adjustable LED Inserts	Style	Color Temperature	Finish
EL6	97 Round Adjustable	27D 2700K (850 lm) 30D 3000K (900 lm)	DXW All White DXB All Black DXBZ All Bronze

*Must be used with PLY™ Housings for 0-10V dimmability (EL770ICDXA, EL770RICDXA, EL76FICDXA, EL760ICDXA, EL760RICDXA).
With non-ply housing this is non-dimmable, 120-277V input only.

6" Accessories



Emergency Battery Backup



Fire Cover



Fire Enclosure



Mica Fire Tape

CAT NO.	SPECIFICATIONS	CAT NO.	SPECIFICATIONS	CAT NO.	SPECIFICATIONS	CAT NO.	SPECIFICATIONS
KEM-LD5	8W, 120/277V	FIRECVR	9 3/4" H x 17" O.D.	FIREENCL	20 3/8" L x 14 3/8" W	FIRETAPE	3/4" W x 16' L
				FIREENCL-S	Shallow, 16" L x 14 3/8" W		

Compatible Products

For use with Dedicated 6" 0-10V Koto ICAD LED Housings

0-10V Koto™ LED Module

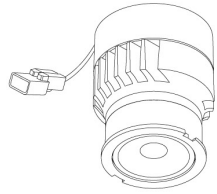

0-10V Koto™
LED Module
ELK10DX

PRODUCT NUMBER BUILDER				
0-10V Koto™ LED Module	Lumens	Voltage	Color Temperature	Beam Angle
ELK				
	10 1000 lm	DX 120/277V	27 2700K	(blank) 38° lens (Standard)
			30 3000K	-S 18° lens
			35 3500K	-N 25° lens
			40 4000K	-W 60° lens
			SD Sunset Dimming	

ACCESSORIES



Lens

- EP731C 18° Lens
 - EP732C 25° Lens
 - EP733C 38° Lens
 - EP734C 60° Lens
- *EP732C, EP733C, EP734C Included



Snoot

- L50W White
- L50B Black



Secondary Optics

- L45 Hex Louver
- L46 Linear Lens
- L47 Spread Louver
- L49 Frosted Lens
- L51 Color Shifter

6" Twist-On Trims

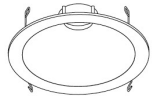

Round Deep Reflector

ELK6418

Finishes:
(W, BB, BZ, H)

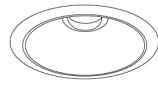

Round Reflector

ELK610

Finishes:
(WW, BB, BZBZ, BW, CC, CW, CN, HW)



Adj. Round Reflector

ELK629

Finishes:
(WW, BB, BZBZ, BW, CW, HW)



Adj. Round Baffle

ELK693

Finishes:
(WW, BB, BZBZ, BW)

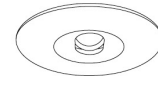

Adj. Slot Aperture

ELK6420

Finishes:
(W)

6" Unique™ Twist-On Trims

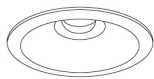

Round Reflector

ELK6710

Finishes:
(W, B, BZ)

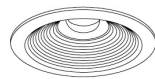

Round Baffle

ELK6713

Finishes:
(W, BZ)



Round Wall Wash

ELK6715

Finishes:
(W, BZ)

6" Accessories

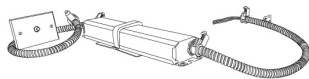

Emergency Battery Backup

CAT NO. SPECIFICATIONS

KEM-LD5 8W, 120/277V

* Requires access from above



Fire Cover

CAT NO. SPECIFICATIONS

FIRECVR 9 3/4" H x 17" O.D.



Fire Enclosure

CAT NO. SPECIFICATIONS

FIREENCL 20 3/8" L x 14 3/8" W

FIREENCL-S Shallow, 16" L x 14 3/8" W



Mica Fire Tape

CAT NO. SPECIFICATIONS

FIRETAPE 3/4" W x 16' L