

4" Sloped Ceiling LED Baffle Insert



Features

- 4" Sloped Ceiling LED Inserts feature an integral gimbal for $\pm 25^\circ$ tilt adjustability.
- Compatible with most incandescent and electronic low voltage dimmers.
- California Title 24 (JA8-2016-E).
- Life Span: 50,000 hours L70.

Specifications

Wattage	12.5WW
Lumens	900 lm
Voltage	120V
Color Temp.	2700K, 3000K, 3500K, 4000K, 5000K
Dimmable	Triac/ELV
Lamp Type	LED
CRI	90+
Damp Location	Listed

Options



White



Bronze

Technical Details

Optics: LED light engine has frosted polycarbonate lens with reflector to diffuse light evenly while reducing glare.

Construction: Deep baffle trim with torsion springs to be held into the housing. High quality powder coat finish preventing rust and paint cracking on metal parts. Integral gimbal allows for 25° adjustability to match slope.

Installation: Designed to install into ELCO 4" Sloped ceiling housing with torsion springs brackets. For retrofitting other manufacturers sloped ceiling cans always test the product to ensure proper fit and function.

Electrical:

- Driver connects to 120VAC power supply.
- High efficiency, high power factor > 0.9 driver.

LED Technology:

- Accurate color rendering with 90+ CRI.
- Lumen Maintenance of 50,000 hours L70 Life based on LM80 standardized test results.
- Superior Thermal Management by utilizing aluminum diecast heat sink.

Dimmability:

- Dimmable with most standard TRIAC and ELV type dimmers.
- Dimming range of 100% down to 10%. Dimming range may vary depending on dimmer model.
- For full list of dimmers refer to the Dimmer Compatibility List.

Compatible Housings: EL470ICA, EL470RICA.

Listings:

- UL Listed for Damp Location.

Dimensions

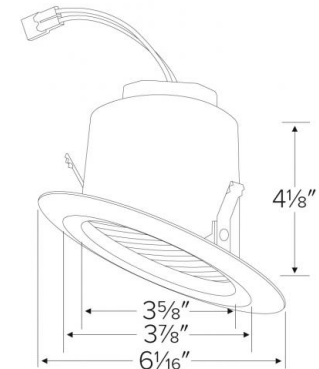

Product Numbers

Item	Lamp type	Lumens	CCT	Watts	Voltage	Dimming	Finish
EL423CT5W	LED	900 lm	2700K, 3000K, 3500K, 4000K, 5000K	12.5W	120V	Triac/ELV	All White
EL423CT5BZ	LED	900 lm	2700K, 3000K, 3500K, 4000K, 5000K	12.5W	120V	Triac/ELV	All Bronze

- California Title 24 (JA8-2016-E).

Warranty: ELCO Products are built to last. 5-year Limited warranty.

Product Number Builder

Example: **EL423CT5W**

4" Sloped Ceiling LED Baffle Insert

Color Temp.

Finish

EL423

CT5 2700K - 5000K

W All White

BZ All Bronze

Compatible Products

For use with **4" LED Sloped Inserts**

4" Dedicated LED Sloped Ceiling ICA Housings

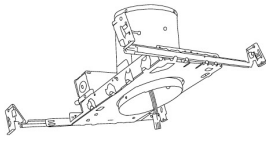

4" Sloped Ceiling Housing
New Construction

CAT NO.	SPECIFICATIONS
EL470ICA	14W MAX.

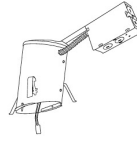

4" Sloped Ceiling Housing
Remodel

CAT NO.	SPECIFICATIONS
EL470RICA	14W MAX.

Photometric Report

4" Sloped Ceiling LED Baffle Insert

PHOTOMETRIC REPORT

Product #: EL423CT5 @2700K
 Wattage / Lumens: 11.8W / 806.2 lm
 Luminaire LPW: 68.3 lm/W

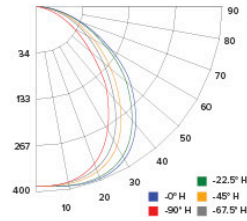

CANDLE POWER SUMMARY

Degree Vertical	0°
0	378
5	386
15	392
25	386
35	364
45	301
55	199
65	98
75	31
85	10
90	1

ILLUMINANCE AT A DISTANCE

Distance to Target Plane	Center Beam Footcandles	Beam Diameter
4'	23.6	7.9'
6'	10.5	11.9'
8'	5.91	15.8'
10'	3.78	19.8'

ZONAL LUMEN SUMMARY

Zone	Lumens	%Luminaire
0-30°	286.9	35.6
0-40°	454.9	56.4
0-60°	708.2	87.9
0-90°	802.3	99.5

PHOTOMETRIC REPORT

Product #: EL423CT5 @3000K
 Wattage / Lumens: 11.7W / 809.4 lm
 Luminaire LPW: 69.2 lm/W

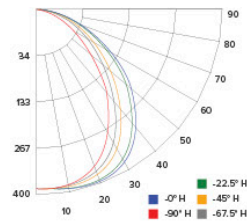

CANDLE POWER SUMMARY

Degree Vertical	0°
0	379
5	388
15	393
25	387
35	367
45	302
55	203
65	99
75	31
85	9
90	1

ILLUMINANCE AT A DISTANCE

Distance to Target Plane	Center Beam Footcandles	Beam Diameter
4'	23.7	7.9'
6'	10.5	11.9'
8'	5.92	15.9'
10'	3.79	19.9'

ZONAL LUMEN SUMMARY

Zone	Lumens	%Luminaire
0-30°	287.4	35.5
0-40°	455.7	56.3
0-60°	710.5	87.8
0-90°	805.5	99.5

PHOTOMETRIC REPORT

Product #: EL423CT5 @3500K
 Wattage / Lumens: 11.8W / 841.6 lm
 Luminaire LPW: 71.3 lm/W

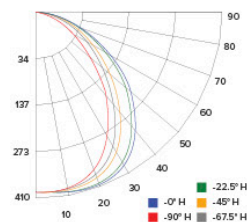

CANDLE POWER SUMMARY

Degree Vertical	0°
0	392
5	401
15	408
25	403
35	382
45	318
55	212
65	106
75	33
85	10
90	1

ILLUMINANCE AT A DISTANCE

Distance to Target Plane	Center Beam Footcandles	Beam Diameter
4'	24.5	7.9'
6'	10.9	11.9'
8'	6.12	15.9'
10'	3.92	19.9'

ZONAL LUMEN SUMMARY

Zone	Lumens	%Luminaire
0-30°	297.5	35.4
0-40°	472.1	56.1
0-60°	737.8	87.7
0-90°	837.5	99.5

Photometric Report

4" Sloped Ceiling LED Baffle Insert

PHOTOMETRIC REPORT

Product #: EL423CT5 @4000K
 Wattage / Lumens: 11.8W / 850.5 lm
 Luminaire LPW: 72.1 lm/W

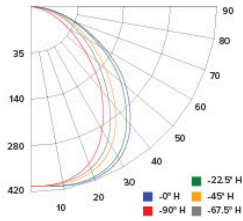

CANDLE POWER SUMMARY

Degress Vertical	0°
0	394
5	404
15	411
25	407
35	387
45	324
55	219
65	110
75	34
85	11
90	1

ILLUMINANCE AT A DISTANCE

Distance to Target Plane	Center Beam Footcandles	Beam Diameter
4'	24.6	8.0'
6'	11.0	11.9'
8'	6.16	15.9'
10'	3.94	19.9'

ZONAL LUMEN SUMMARY

Zone	Lumens	%Luminaire
0-30°	299.5	35.2
0-40°	475.3	55.9
0-60°	744.6	87.5
0-90°	846.3	99.5

PHOTOMETRIC REPORT

Product #: EL423CT5 @5000K
 Wattage / Lumens: 11.8W / 861.9 lm
 Luminaire LPW: 73 lm/W

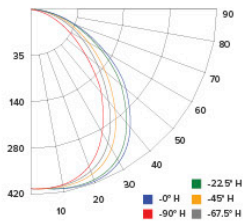

CANDLE POWER SUMMARY

Degress Vertical	0°
0	398
5	408
15	416
25	413
35	393
45	329
55	225
65	113
75	35
85	11
90	1

ILLUMINANCE AT A DISTANCE

Distance to Target Plane	Center Beam Footcandles	Beam Diameter
4'	24.9	8.0'
6'	11.1	12.0'
8'	6.22	16.0'
10'	3.98	19.9'

ZONAL LUMEN SUMMARY

Zone	Lumens	%Luminaire
0-30°	302.5	35.1
0-40°	480.1	55.7
0-60°	753.9	87.5
0-90°	857.6	99.5



ELCO Lighting

Dimmer Compatibility Chart

4" / 5" / 6" Sloped Ceiling LED Inserts

For EL423CT5, EL425CT5, EL511CT5, EL512CT5, EL715CT5, and EL716CT5

For Reference Only

Testing conducted by ELCO Lighting is not a substitute for and does not imply certification by an independent laboratory or any other standards certification. Refer to manufacturer specifications for more detailed information on product certifications and standards. Consult the dimmer manufacturer prior to installation to ensure compatibility.

Manufacturer	Product	Part Number	Dimmed Light Output Range
Lutron	Skylark Contour, 120V AC, 60Hz, 600W Incandescent/Halogen, Single Pole, 3-Way Indoor Application, Residential/Commercial Application	CT-603PG / CT-600PR	10% - 100%
	Diva, 120V AC, 60Hz, 600W Incandescent/Halogen, Single Pole, 3-Way, Residential/Commercial Application	DV-600PR / DV603PG	10% - 100%
	Diva, 120V, 60Hz, 150W LED/CFL, 600W Incandescent/Halogen, Single Pole, 3-Way	DVW-603PGH / DVCL-153P	10% - 100%
	Maestro, 120V, 50/60Hz, 150W LED/CFL, 600W Incandescent/Halogen, Single Pole, 3-Way	MACL-153M / TGCL-153P	10% - 100%
	Skylark, Single Pole 600W Incandescent/Halogen, Slide-to-Off Dimmer	S-600PR / S-2-LH	10% - 100%
Leviton		1A1505 / IC1605	10% - 100%
	SureSlide, 120V AC 60Hz, 600W for LED and CFL, 600W for Incandescent, Single Pole, 3-Way, Polycarbonated Housing	6631 / 6633	10% - 100%
Cooper	Decorator Dimmer, 120V 60Hz, 300W for LED and CFL, 600W for Incandescent, Single Pole, 3-Way, Polycarbonated Housing	DLC03P	10% - 100%

***NOTE: Refer to dimmer manufacturer's documentation for installation instructions and circuit details**

Disclaimer: Minimum and maximum loads for LEDs and CFLs are given in number of lamps and may vary depending on the lamp being used. Testing conducted by ELCO Lighting is not a substitute for and does not imply certification by an independent laboratory or any other standards certification. Refer to manufacturer specifications for more detailed information on product certifications and standards.

Integrating our lighting with your Smart Home System is a breeze. Simply check your Smart Home system for compatible smart switches and cross reference that with our Dimming Compatibility Chart. Once the switches are integrated with your Smart Home system your lights will be ready to go.



2042 E. Vernon Ave. Vernon CA 90058 Tel 323.231.2600 Fax 323.231.3200 elcolighting.com