

# 4" New Construction 2-Hour Fire Rated IC Housing

4" fire rated new construction LED housing. Compatible with MR16 LED lamps with quick connect base or 4" LED inserts. 2-hour fire rated, can include step-down transformer.



## Features

- UL Listed for 2-Hour Fire Resistance to meet and exceed strict fire safety codes.
- Integrated Non-combustible insulation acts as a sound barrier minimizing sound transfer between floors.
- Meets Title 24 requirements.
- Trims and inserts sold separately.

## Specifications

<b>Wattage</b>	14W
<b>Voltage</b>	120V or 277V
<b>Damp Location Listed</b>	

## Dimensions

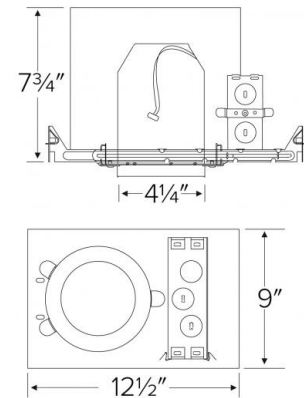

## Technical Details

### Construction:

- Double wall IC rated for direct contact with insulation. For use in IC and non-IC conditions.
- Housing adjusts in frame to accommodate up to 1 1/2" ceiling thickness.
- Airtight housing with gasket to restrict airflow in accordance with ASTM E-283 air-tight requirements.

### Installation:

- Designed for ceiling plenums where 2x8 joists or taller are used.
- High strength hanger bars can easily be nailed to joists.
- Suitable for T-grid and drop ceiling applications.
- See installation sheet for detailed information.

**Junction Box:** Positioned to accommodate straight conduit runs. Two 3/4" knockouts, Seven 1/2" trade size conduit knockouts, One 3/8" knockout. Four Pry-out knockout slots for easy romex installation.

**Hanger Bars:** Pre Installed hanger bars with True Nail easy installation in regular lumber, engineered lumber, and Laminated Beams. Integral T-bar slots for easy installation in T-Bars. Spans up 24" and can be repositioned 90°. Score lines allow for tool-free hanger bar size reduction. Integral leveling flange allows for single-person installation while easily aligning the housings with the joists.

**Listings:** UL Listed for Damp Location and for Wet Location with select trims. UL Listed for Direct Contact with Insulation and Combustible Material. UL Listed for Feed Through.

## Product Numbers

Item	Description	Watts	Voltage
<b>EL49FICA</b>		14W	120V
<b>EL49FICA-7</b>	with Step-down Transformer	14W	277V

# Compatible Products

For use with Dedicated 4" IC LED Housings

## Koto™ LED Module

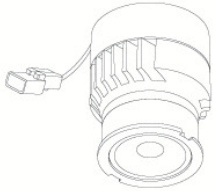

**Koto™ LED Module**  
ELK07 - ELK09

### PRODUCT NUMBER BUILDER

Koto™ LED Module	Lumens	Color Temperature	Beam Angle
<b>ELK</b>			
<b>07</b>	750 lm	<b>27</b> 2700K	<b>(blank)</b> 38° lens (Standard)
<b>09</b>	950 lm	<b>30</b> 3000K	<b>-S</b> 18° lens
		<b>35</b> 3500K	<b>-N</b> 25° lens
		<b>40</b> 4000K	<b>-W</b> 60° lens
		<b>SD</b> Sunset Dimming (ELK09 Only)	

### ACCESSORIES



#### Lens

<b>EP731C</b>	18° Lens
<b>EP732C</b>	25° Lens
<b>EP733C</b>	38° Lens
<b>EP734C</b>	60° Lens

\*EP732C, EP733C, EP734C Included

#### Reflectors

<b>EP735C</b>	15°
<b>EP736C</b>	25°
<b>EP737C</b>	38°
<b>EP738C</b>	60°

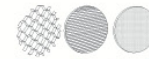

#### Secondary Optics

<b>L45</b>	Hex Louver
<b>L46</b>	Linear Louver
<b>L47</b>	Spread Louver

## 4" Pex™ Twist-&-Lock Trims



#### Reflector

**ELK4118**  
Finishes:  
(W, BB, BZ, B, C, H)



#### Adjustable Gimbal

**ELK4129**  
Finishes:  
(W, BB, BZ, B, C, H)



#### Adjustable Pinhole

**ELK4127**  
Finishes:  
(B, BB, BZ)



#### Adjustable Baffle

**ELK4193**  
Finishes:  
(W, BB, B)



#### Reflector

**ELK4218**  
Finishes:  
(W, BB, BZ, B, C, H)



#### Adjustable Gimbal

**ELK4229**  
Finishes:  
(W, BB, BZ, B, C, H)



#### Adjustable Pinhole

**ELK4227**  
Finishes:  
(B, BB, BZ)

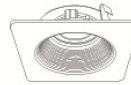

#### Adjustable Phenolic Baffle

**ELK4293**  
Finishes:  
(W, BB, B)

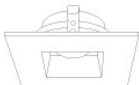

#### Adjustable Reflector

**ELK4282**  
Finishes:  
(W)

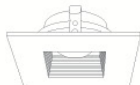

#### Adjustable Baffle

**ELK4284**  
Finishes:  
(W)

\*Finishes: **W** - All White, **BB** - All Black, **BZ** - All Bronze, **B** - Black Reflector w/White Ring, **C** - Chrome Reflector w/White Ring, **H** - Haze Reflector w/White Ring

# Compatible Products

For use with Dedicated 4" IC LED Housings

## 4" Pex™ Adjustable Trimless

---



Smooth Reflector

ELK430

Finishes:

(W, B, BZ)



Baffle

ELK434

Finishes:

(W, B, BZ)

## 4" Flexa™ Twist-&-Lock Trims

---



Round Reflector

ELK4721

Finishes:

(WW, BB, BZBZ, BW, CC, CW,  
HW, CN)

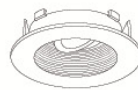

Round Baffle

ELK4723

Finishes:

(WW, BB, BZBZ, BW)

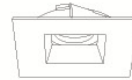

Square Reflector

ELK4741

Finishes:

(WW, BB, BZBZ, BW, HW)

*\*Not for Remodel Housing*

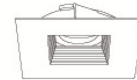

Square Baffle

ELK4743

Finishes:

(WW, BB, BZBZ, BW)

*\*Not for Remodel Housing*

\*Finishes: **W** - All White, **WW** - All White, **B** - Black, **BB** - All Black, **BZ** - All Bronze, **CC** - All Chrome, **BZBZ** - All Bronze, **BW** - Black Reflector w/White Ring, **CW** - Chrome Reflector w/White Ring, **CN** - Chrome Reflector w/Nickel Ring, **HW** - Haze Reflector w/White Ring

# Compatible Products



For use with Dedicated 4" IC LED Housings

## 4" Cedar™ LED Light Engines



**Round Reflector**

**E410R**

Finishes:

(W, BB, BZ, B, C, H, MW, MB)



**Round Wall Wash Reflector**

**E411R**

Finishes:

(W, BB, BZ, B, C, H, MW, MB)



**Round Drop Glass**

**E412R**

Finishes:

(W, BB, BZ, B, C, H, MW, MB)



**Round Baffle**

**E414R**

Finishes:

(W, BB, BZ, B)



**Square on Square Baffle**

**E415R**

Finishes:

(W, BZ)



**Square on Square Reflector**

**E417R**

Finishes:

(W, BZ, C, H)



**Square on Round Reflector**

**E420R**

Finishes:

(W, BB, BZ, C, H, MW, MB)



**Square on Round Baffle**

**E424R**

Finishes:

(W, BB, BZ, B)

### PRODUCT NUMBER BUILDER

4" LED Module & Driver	Style	Lumens	Color Temperature	Finish
<b>E4</b>				
<b>10R</b>	Round Reflector	<b>08</b> 850 lm (10.5W)	<b>27</b> 2700K	<b>W</b> All White
<b>11R</b>	Round Wall Wash Reflector		<b>30</b> 3000K	<b>BB</b> All Black
<b>12R</b>	Round Drop Glass		<b>35</b> 3500K	<b>BZ</b> All Bronze
<b>14R</b>	Round Baffle		<b>40</b> 4000K	<b>B</b> Black w/White Ring
<b>15R</b>	Sq. on Sq. Baffle		<b>SD</b> Sunset Dimming	<b>C</b> Chrome w/White Ring
<b>17R</b>	Sq. on Sq. Reflector			<b>H</b> Haze w/White Ring
<b>20R</b>	Sq. on Round Reflector			<b>MW</b> Matte White
<b>24R</b>	Sq. on Round Baffle			<b>MB</b> Matte Black

# Compatible Products



For use with Dedicated 4" IC LED Housings

## 4" Ply™ 120/277V LED Inserts



### Round Insert

**EL495**

Finishes:

(DW, DHW, DCW)

PRODUCT NUMBER BUILDER			
4" 120/277V LED Inserts	Color Temperature		Finish
<b>EL495</b>			
	<b>30</b>	3000K (800 lm)	<b>DW</b> All White
	<b>35</b>	3500K (850 lm)	<b>DHW</b> Haze w/White Ring
	<b>40</b>	4000K (900 lm)	<b>DCW</b> Chrome w/White Ring

*\*Must be used with PLY™ Housings for 0-10V dimmability (EL490ICDXA, EL490RICDXA, EL492ICDXA, EL492RICDXA). With non-ply housing this is non-dimmable, 120-277V input only.*

## 4" Ply™ 120/277V Adjustable LED Inserts



### Round Adjustable Gimbal

**EL414**

Finishes:

(DXW, DXB)



### Round Adjustable Insert

**EL497**

Finishes:

(DXW, DXB, DXBZ DXN)



### Square Adjustable Insert

**EL447**

Finishes:

(DXW, DXB, DXBZ DXN)

### ACCESSORIES



### Interchangeable Lens

(For EL497 & EL447 Series only)

**EP710C** 20° Beam  
**EP712C** 60° Beam

PRODUCT NUMBER BUILDER			
4" 120/277V Adjustable LED Inserts	Style	Color Temperature	Finish
<b>EL4</b>			
	<b>14</b> Adjustable Gimbal	<b>27D</b> 2700K	<b>DXW</b> All White
	<b>97</b> Round Adjustable	<b>30D</b> 3000K	<b>DXB</b> All Black
	<b>47</b> Square Adjustable		<b>DXBZ</b> All Bronze
			<b>DXBN</b> All Nickel

*\*Must be used with PLY™ Housings for 0-10V dimmability (EL490ICDXA, EL490RICDXA, EL492ICDXA, EL492RICDXA). With non-ply housing this is non-dimmable, 120-277V input only.*