

4" LED Module & Driver with Wall Wash Reflector Trim

The perfect lighting solution for high-end residential projects with existing housings.



Features

- Module includes LED Module Driver.
- Triac/ELV/0-10V dimming.
- Can be used in dedicated LED housings from ELCO or used to retrofit medium base (E26) housings.
- Life span of 50,000 hours L70.
- USA designed and assembled.
- Limited 5 year warranty.

Specifications

Wattage	11.4W
Lumens	850 lm
Voltage	120V
Color Temp.	5000K
Dimmable	Triac/ELV
Lamp Type	LED
Beam Angle	60°
CRI	93+
Wet Location	Listed

Options



All White



Black w/White ring



All Bronze



Chrome



Haze w/White ring



All Black

Technical Details

Optics: Frosted polycarbonate module lens diffuses light evenly throughout while reducing glare with LED technology.

Trim Construction: Reflector is two piece trim for maximum color versatility. Design allows for minimal glare and a strong glare cut-off. Trim is constructed of metal for lasting durability.

LED Technology:

- Extremely accurate Color Rendering Index of 93+.
- Efficacy of 97 lumens per watt.
- Lumen Maintenance of 50,000 hours L70 Life based on LM80 standardized test results.
- Superior Thermal Management by utilizing ELCO Red heat sink.
- Instant On to Full Brightness technology.
- No LED pixilation.

Sunset: Sunset color temperature is our dim-to-warm LED technology that allows the color temperature to become warmer as the product is dimmed. Our SUNSET items start at 3000K and go as low as 1800K when dimmed. For Sunset dim technology be sure to order an item with "Sunset" in the Color Temperature (CCT) attribute.

Listings: cUL Listed for Wet Location. RoHS Compliant. California Title 24 (JA8-2016-E).

Dimensions

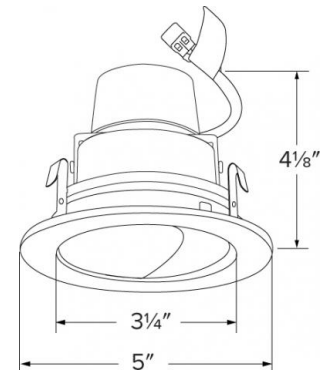

Product Number Builder Example: E411R0827W

ELCO 4" Wall Wash Reflector	Lumens	Color Temp.	Finish	Beam Angle
E411R	08 850 lm	27 2700K 30 3000K 35 3500K 40 4000K 50 5000K SD Sunset ¹	W All White BB All Black BZ All Bronze B Black w/White Ring C Chrome with White Trim H Haze with White Trim MW Matte White MB Matte Black	60° lens -F 38° lens -N 24° lens -S 15° lens

¹ Sunset, Dim to Warm technology, automatically transitions from 3000K to 1800K when dimmed

For use with **4" LED Inserts**

4" Dedicated LED IC Housings



4" 2-Hour Fire Rated
New Construction



4" LED Housing
New Construction



4" LED Housing
Remodel

CAT NO.	SPECIFICATIONS	CAT NO.	SPECIFICATIONS	CAT NO.	SPECIFICATIONS
EL49FICA	14W Max.	EL490ICA	14W Max.	EL490RICA	14W Max.

4" E26 Base Housings



4" IC Housing
New Construction



4" IC Housing
Remodel



4" Non-IC Housing
New Construction



4" Non-IC Housing
Remodel

CAT NO.	SPECIFICATIONS	CAT NO.	SPECIFICATIONS	CAT NO.	SPECIFICATIONS	CAT NO.	SPECIFICATIONS
EL99ICA	50W Max.	EL99RICA	50W Max.	EL99A	50W Max.	EL99RA	50W Max.



PSA30
Medium base to Ideal terminal connector



PSA31
GU10 to Ideal connector
PSA31 Available for retrofitting
GU10 housings (Not shown above)



ELCO Lighting

Dimmer Compatibility Chart LED Module & Driver

For Reference Only

Testing conducted by ELCO Lighting is not a substitute for and does not imply certification by an independent laboratory or any other standards certification. Refer to manufacturer specifications for more detailed information on product certifications and standards. Consult the dimmer manufacturer prior to installation to ensure compatibility.

Manufacturer	Product	Part Number	Dimmed Light Output Range
Triac/ELV			
Cooper	ASPIRE Decorator Single Pole/3-Way Dimmer	9573WS	10% - 100%
	DEVINE Decorator Dimmer	DI06P-A-K	10% - 100%
Legrand	Adorne® Paddle 450W Single Pole/3-Way Dimmer	ADPD453L-W2	10% - 100%
Leviton	Illumatech Single Pole/3-Way Incandescent Dimmer	IPI06	10% - 100%
	Decora Sureslide Single Pole Slide-to-Off Incandescent Dimmer	6631-LW	10% - 100%
	Decora Sureslide Single Pole/3-Way Magnetic Low Voltage Dimmer	6613-PL	8% - 100%
Lutron	Skylark® Single Pole/3-Way Incandescent/Halogen "Eco-Dim" Dimmer	S-603PG	5% - 85%
	Diva® C•L Single Pole/3-Way Dimmer	DVCL-153PR	7%-100%
	Ariadni Single Pole/3-Way Dimmer	AY-600P-AL	10% - 100%
	Maestro® Incandescent/Halogen Digital Fade Dimmer	MRF2-600M-WH	10% - 100%
	Skylark® Single Pole/3-Way Incandescent/Halogen Dimmer	S-600P-AL	10% - 100%
	Diva® Single Pole Incandescent/Halogen Dimmer	DV-600P-WH	10% - 100%
	Nova® Single Pole Incandescent/Halogen Slide-to-Off Dimmer	N-600	10% - 100%
	Skylark® Single Pole Magnetic Low Voltage Dimmer	SLV-600-WH	8% - 100%
Glyder® Single Pole Magnetic Low Voltage Dimmer	GLV-600-WH	8% - 100%	

*NOTE: Refer to dimmer manufacturer's documentation for installation instructions and circuit details

Disclaimer: Minimum and maximum loads for LEDs and CFLs are given in number of lamps and may vary depending on the lamp being used. Testing conducted by ELCO Lighting is not a substitute for and does not imply certification by an independent laboratory or any other standards certification. Refer to manufacturer specifications for more detailed information on product certifications and standards.