

4" Cedar System Non-IC Remodel Housing w/Driver

Non-IC Airtight remodel housing for high-end residential and light commercial, 850 to 1600 lumens.



Features

- Optional 90 minutes, 120/277 VAC, 60Hz, Emergency Backup.
- Flicker-Free Dimming.
- USA designed and assembled.
- Limited 5 year warranty.
- For use with ELCO Cedar™ System 4" LED Light Engines.
- 2 at the end of the item number denotes Generation 2. Please note Gen 2 and Gen 1 are not cross compatible.

Specifications

Lumens	1250 lm
Voltage	120/277V
Dimmable	Sunset
Power Factor	≥0.95
Damp Location	Listed

Options



Optional EM

Technical Details

Construction:

- Non-IC Frame for non-IC conditions.
- Airtight housing with gasket to restrict airflow in accordance with ASTM E-283 air-tight requirements.

Installation:

- Designed for ceiling plenums where 2x6 joists or taller are used.
- Suitable for T-grid and drop ceiling applications.
- See installation sheet for detailed information.

Junction Box: Positioned to accommodate straight conduit runs. Two 3/4" knockouts, Seven 1/2" trade size conduit knockouts, One 3/8" knockout. Four Pry-out knockout slots for easy romex installation.

Electrical:

- Driver is rated for 120V and 277V input (120/277V).
- High Efficiency driver with a power factor > 0.95.

Dimmability:

- 3 in 1 dimming: Triac, ELV and 0-10V dimming in one driver.
- 0-10V dimming down to 5% with compatible dimmer.
- Can be specified with Lutron drivers for 0.1% and 1% dimming.
- For full list of dimmers refer to the Dimmer Compatibility List.

Listings: cUL Listed for Damp Location and for Wet Location with select trims. cUL Listed for Feed Through.

Dimensions

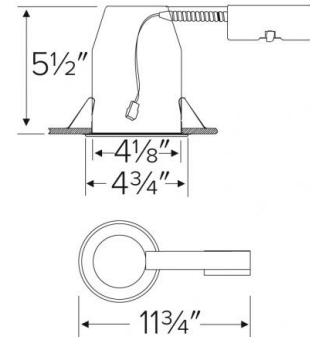

Product Number

Item	Lumens	Voltage	Dimming
E4LRC12SD	1250 lm	120/277V	Sunset

Product Number Builder Example: E4LRC082

ELCO Cedar 4" Remodel Housing	Lumens	Dimming	Generation	Optional
E4LRC				
	08 850 lm 12 1250 lm 16 1600 lm	120V Triac/ELV D 120/277V Triac/ELV/0-10V SD Sunset L Lutron	2 Gen 2 Gen 1	No EM EM1 Emer. Backup up to 700 lm EM2 Emer. Backup to 1100 lm

Compatible Products



For use with 4" Cedar™ Non-IC LED housings

4" Cedar™ LED Light Engines



Round Reflector Trim

E410C

Finishes:

(W, B, C, H, BZ, BB, MW, MB)



Wall Wash Reflector Trim

E411C

Finishes:

(W, B, C, H, BZ, BB, MW, MB)



Drop Glass Reflector Trim

E412C

Finishes:

(W, B, C, H, BB, MW, MB)



Round Baffle Trim

E414C

Finishes:

(W, B, BZ, BB)



Round Pinhole Trim

E429C

Finishes:

(W, B, C)



Square on Sq. Baffle Trim

E415C

Finishes:

(W, BZ)



Square on Sq. Reflector Trim

E417C

Finishes:

(W, BZ)



Round on Sq. Reflector Trim

E420C

Finishes:

(W, C, H, BZ, BB)



Round on Sq. Baffle Trim

E424C

Finishes:

(W, B, BZ, BB)



Round Adjustable Trim

E418C

Finishes:

(W, C, BB, BZ)



Square Adjustable Trim

E428C

Finishes:

(W, C, BB, BZ)

PRODUCT NUMBER BUILDER

4" Cedar™ Trim	Style	Lumen	Color Temperature	Finish
E4				
10C	Reflector	08 850 lm (8.76W)	27 2700K	W All White
11C	Wall Wash	12 1250 lm (12.88W)	30 3000K	B Black w/White Ring
12C	Drop Glass	16 1600 lm (18W)	35 3500K	BZ All Bronze
14C	Baffle		40 4000K	BB All Black
15C	Sq. on Sq. Baffle		50 5000K	C Chrome w/White Ring
17C	Sq. on Sq. Reflector		SD Sunset Dimming	H Haze w/White Ring
18C	Round Adjustable			MW Matte White
20C	Round on Sq. Reflector			MB Matte Black
24C	Round on Sq. Baffle			
28C	Square Adjustable			

Compatible Products

For use with 4" Cedar™ Non-IC LED housings

4" Accessories



Fire Cover

CAT NO.	SPECIFICATIONS
FIRECVR	9 3/4" H x 17" O.D.



Fire Enclosure

CAT NO.	SPECIFICATIONS
FIREENCL	20 3/8" L x 14 3/8" W
FIREENCL-S	Shallow, 16" L x 14 3/8" W



Mica Fire Tape

CAT NO.	SPECIFICATIONS
FIRETAPE	3/4" W x 16' L